

STRADA-2X2-PXL

Fully asymmetric beam designed to highlight pedestrian crossings for left side traffic

SPECIFICATION:

Dimensions	50.0 x 50.0
Height	8 mm
Fastening	pin, screw
ROHS compliant	yes ⓘ



MATERIALS:

Component	Type	Material	Colour	Finish	Length (mm)
STRADA-2X2-PXL	Multi-lens	PMMA	clear		

ORDERING INFORMATION:

Component	Qty in box	MOQ	MPQ	Box weight (kg)
C14896_STRADA-2X2-PXL » Box size: 480 x 280 x 300 mm	800	160	160	7.9

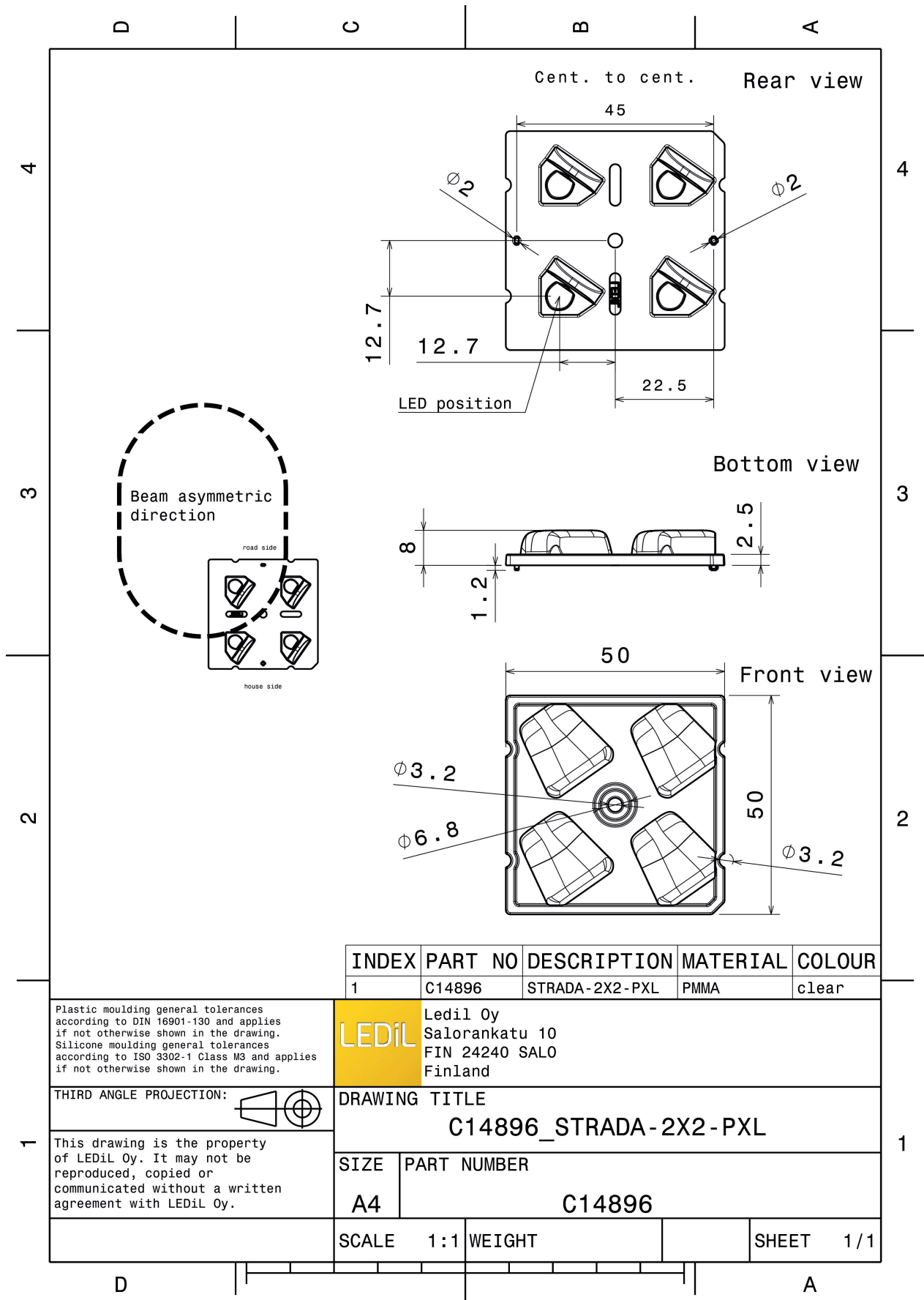

See also our general installation guide: www.ledil.com/installation_guide

OPTICAL RESULTS (MEASURED):



LED XD16
FWHM / FWTM Asymmetric
Efficiency 94 %
Peak intensity 1.2 cd/lm
LEDs/each optic 1
Light colour/type White
Required components:

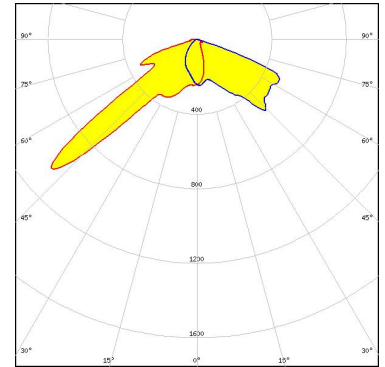

Light distribution files



LED LUXEON 5050 Round LES
FWHM / FWTM Asymmetric
Efficiency 94 %
Peak intensity 0.8 cd/lm
LEDs/each optic 1
Light colour/type White
Required components:

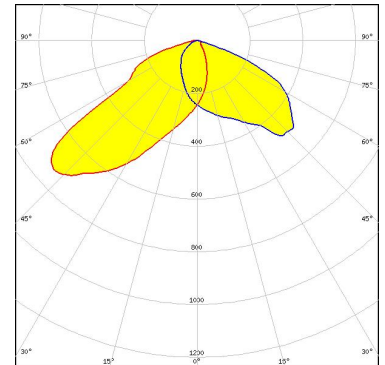

Light distribution files



LED LUXEON MZ
FWHM / FWTM Asymmetric
Efficiency 94 %
Peak intensity 0.9 cd/lm
LEDs/each optic 1
Light colour/type White
Required components:

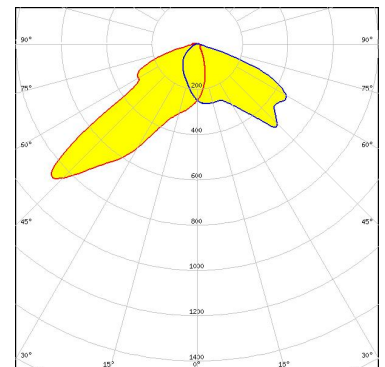

Light distribution files

OPTICAL RESULTS (MEASURED):



LED LUXEON V
FWHM / FWTM Asymmetric
Efficiency 94 %
Peak intensity 0.8 cd/lm
LEDs/each optic 1
Light colour/type White
Required components:

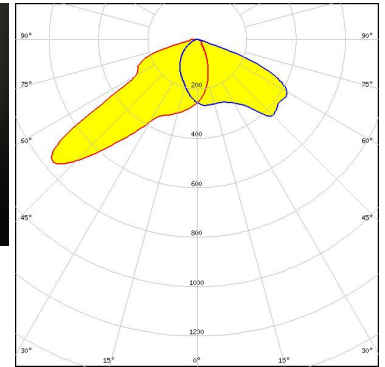
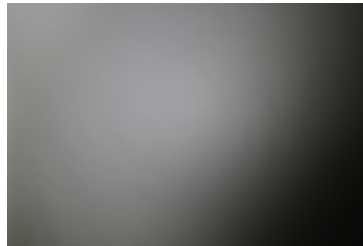

Light distribution files



LED RecLED 122x50mm 1900lm 730 2x4 Opt G1
FWHM / FWTM Asymmetric
Efficiency 98 %
Peak intensity 1.2 cd/lm
LEDs/each optic 1
Light colour/type White
Required components:

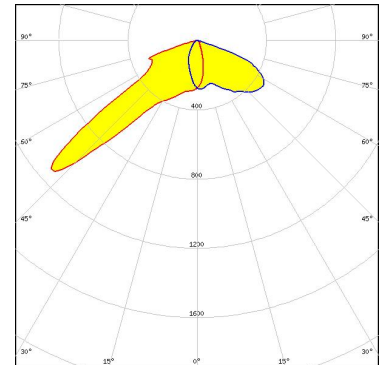

Light distribution files



LED NVSW219F-V2
FWHM / FWTM Asymmetric
Efficiency 94 %
Peak intensity 0.9 cd/lm
LEDs/each optic 1
Light colour/type White
Required components:

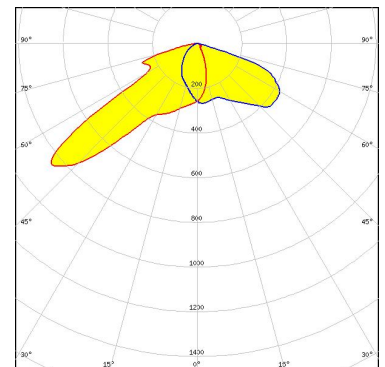

Light distribution files

OPTICAL RESULTS (MEASURED):



LED NVSW319B
FWHM / FWTM Asymmetric
Efficiency 94 %
Peak intensity 0.9 cd/lm
LEDs/each optic 1
Light colour/type White
Required components:

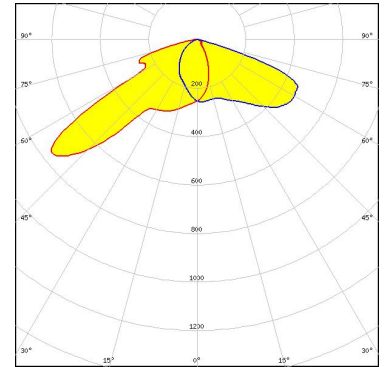

Light distribution files



LED NVSxE21A
FWHM / FWTM Asymmetric
Efficiency 94 %
Peak intensity 1.4 cd/lm
LEDs/each optic 1
Light colour/type White
Required components:

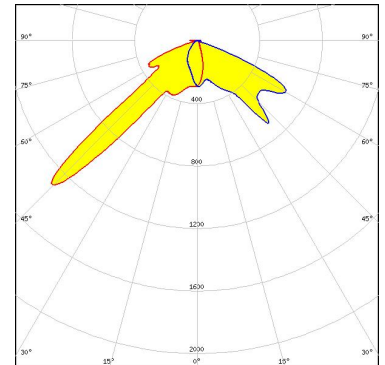

Light distribution files



LED OSLOM Square PC
FWHM / FWTM Asymmetric
Efficiency 94 %
Peak intensity 1.1 cd/lm
LEDs/each optic 1
Light colour/type White
Required components:

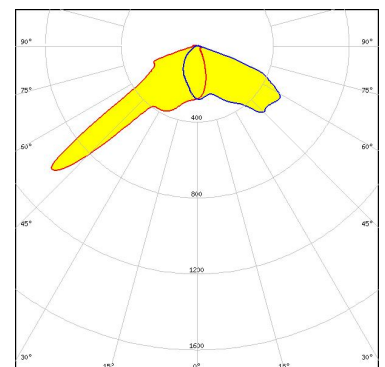

Light distribution files

OPTICAL RESULTS (MEASURED):

SAMSUNG

LED HiLOM RC12 Z (LH181B)
FWHM / FWTM Asymmetric
Efficiency 97 %
Peak intensity 1.3 cd/lm
LEDs/each optic 1
Light colour/type White
Required components:

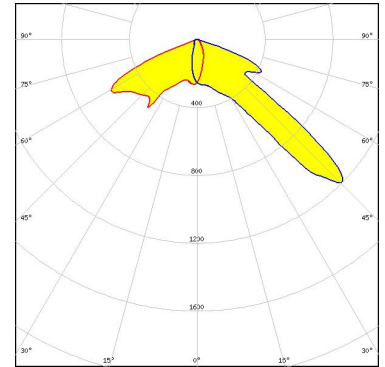

Light distribution files

SAMSUNG

LED HiLOM RH12 Z (LH351C)
FWHM / FWTM Asymmetric
Efficiency 97 %
Peak intensity 1 cd/lm
LEDs/each optic 1
Light colour/type White
Required components:

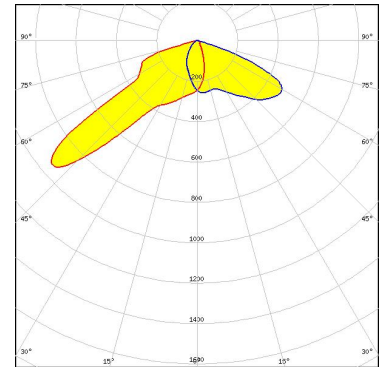

Light distribution files

SAMSUNG

LED HiLOM RH16 (LH351C)
FWHM / FWTM Asymmetric
Efficiency 94 %
Peak intensity 1 cd/lm
LEDs/each optic 1
Light colour/type White
Required components:

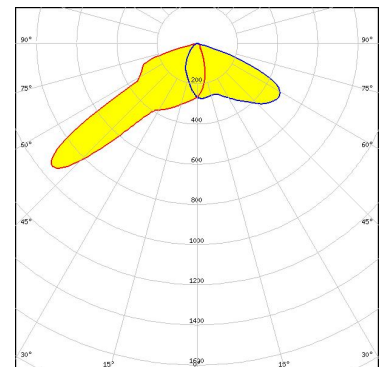

Light distribution files

OPTICAL RESULTS (MEASURED):

SAMSUNG

LED HiLOM RM12 Z (LH502C)
FWHM / FWTM Asymmetric
Efficiency 97 %
Peak intensity 0.9 cd/lm
LEDs/each optic 1
Light colour/type White
Required components:

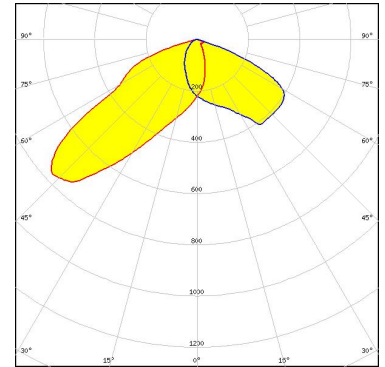

Light distribution files

SAMSUNG

LED HiLOM RM16 Z (LH502C)
FWHM / FWTM Asymmetric
Efficiency 97 %
Peak intensity 0.9 cd/lm
LEDs/each optic 1
Light colour/type White
Required components:

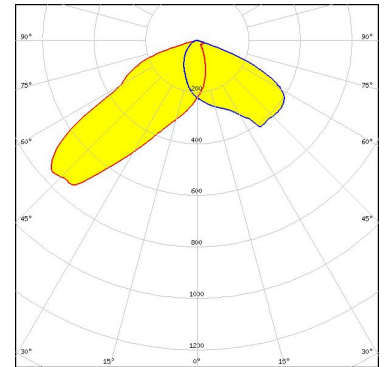

Light distribution files

SAMSUNG

LED HiLOM RM16 Z (LH502C)
FWHM / FWTM Asymmetric
Efficiency 90 %
Peak intensity 0.9 cd/lm
LEDs/each optic 1
Light colour/type White
Required components:

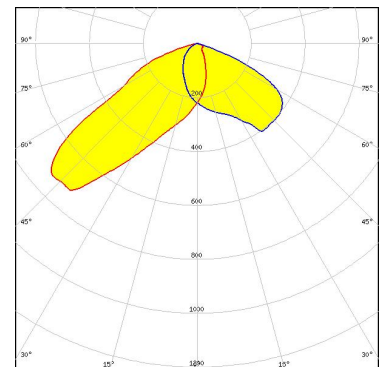

Protective plate, glass

Light distribution files

OPTICAL RESULTS (MEASURED):

SAMSUNG

LED HiLOM RM8 Z (LH502C)
FWHM / FWTM Asymmetric
Efficiency 92 %
Peak intensity 0.9 cd/lm
LEDs/each optic 1
Light colour/type White
Required components:

Protective plate, glass

Light distribution files

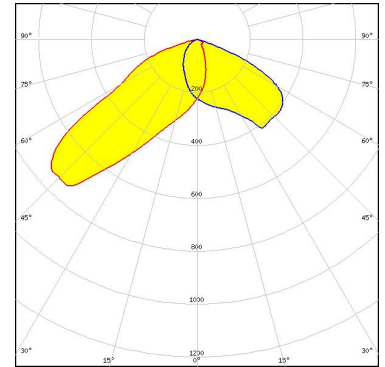

SAMSUNG

LED HiLOM RM8 Z (LH502C)
FWHM / FWTM Asymmetric
Efficiency 97 %
Peak intensity 0.9 cd/lm
LEDs/each optic 1
Light colour/type White
Required components:

Light distribution files

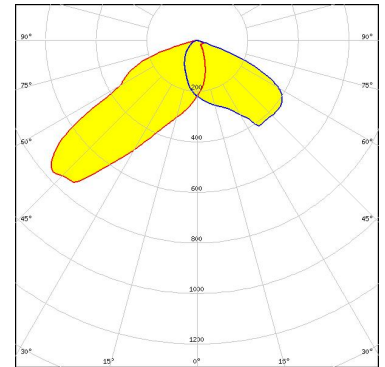

SAMSUNG

LED LH351B
FWHM / FWTM Asymmetric
Efficiency 94 %
Peak intensity 0.9 cd/lm
LEDs/each optic 1
Light colour/type White
Required components:

Light distribution files

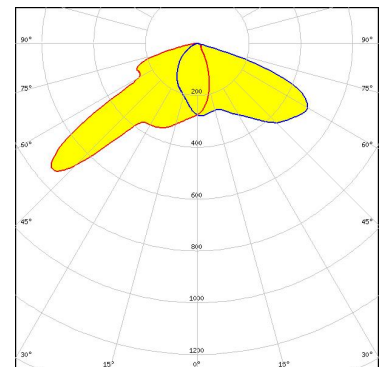

OPTICAL RESULTS (MEASURED):

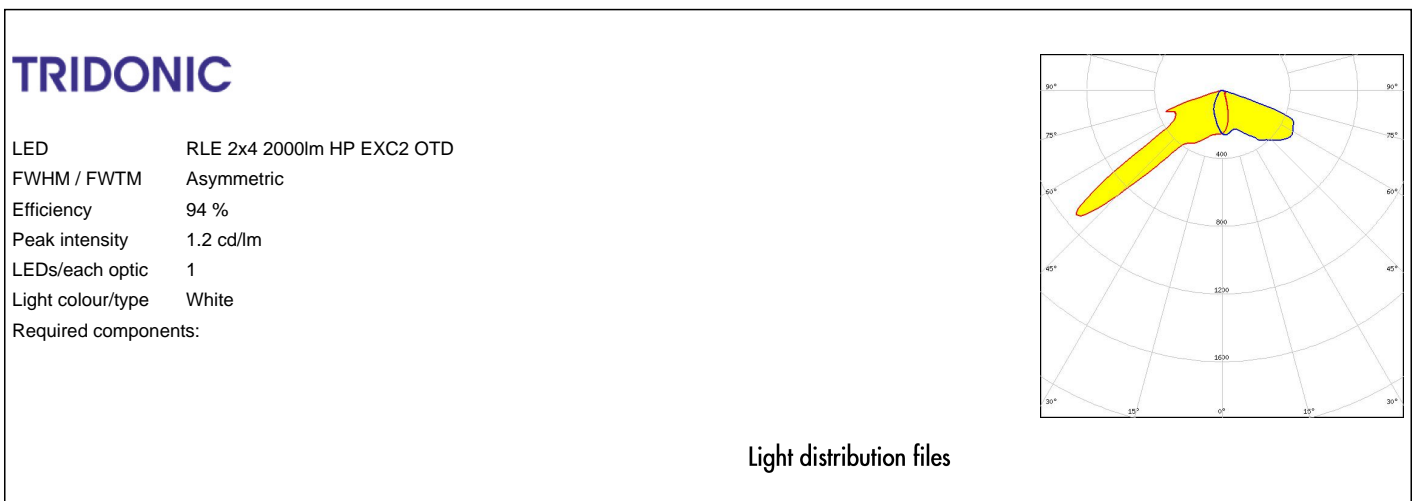
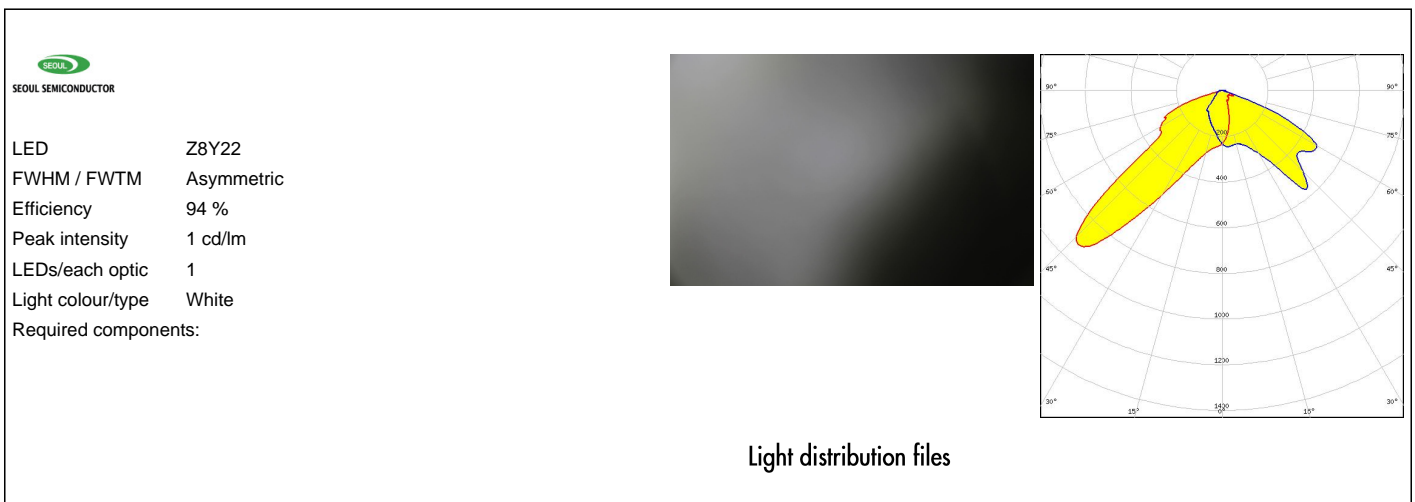
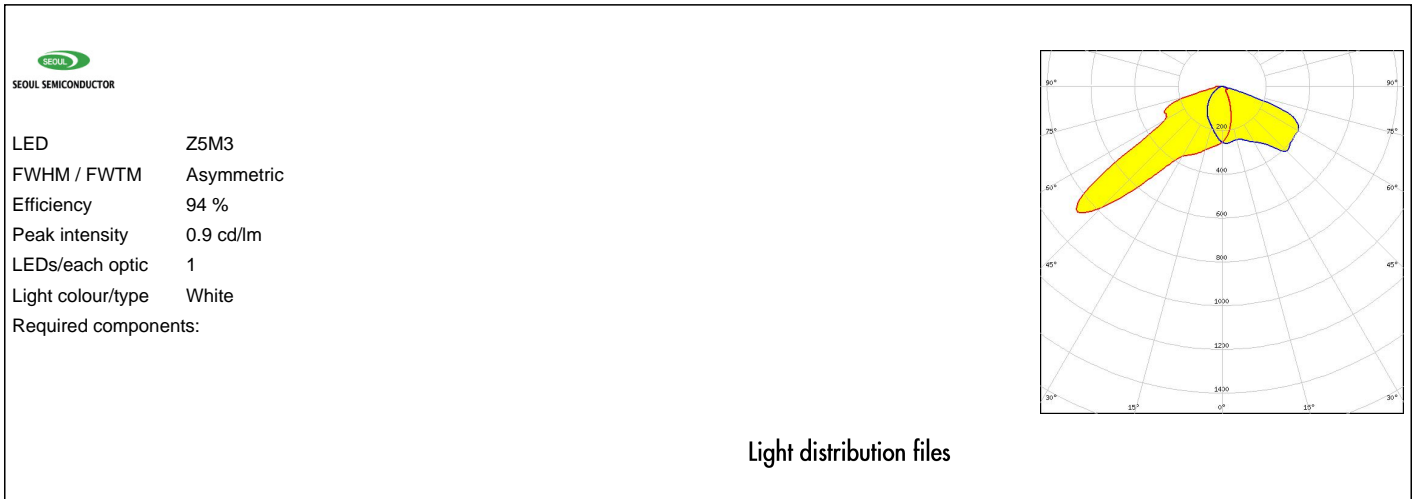

OPTICAL RESULTS (MEASURED):

TRIDONIC

LED RLE 2x8 4000lm HP EXC2 OTD
FWHM / FWTM Asymmetric
Efficiency 94 %
Peak intensity 1.2 cd/lm
LEDs/each optic 1
Light colour/type White
Required components:

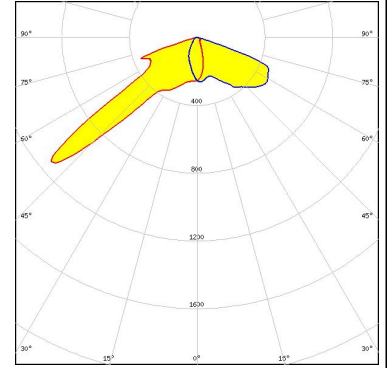

Light distribution files

OPTICAL RESULTS (SIMULATED):



LED J Series 5050B 6V K Class
 FWHM / FWTM Asymmetric
 Efficiency 87 %
 Peak intensity 0.8 cd/lm
 LEDs/each optic 1
 Light colour/type White
 Required components:

Protective plate, glass

Light distribution files

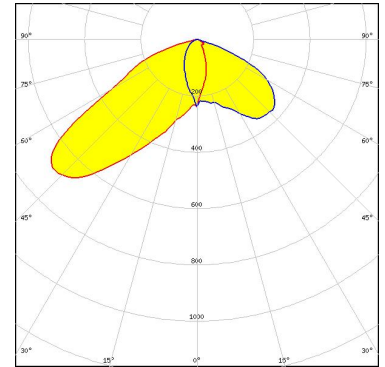

LED XP-G2
 FWHM / FWTM Asymmetric
 Efficiency 95 %
 Peak intensity 1.1 cd/lm
 LEDs/each optic 1
 Light colour/type White
 Required components:

Light distribution files

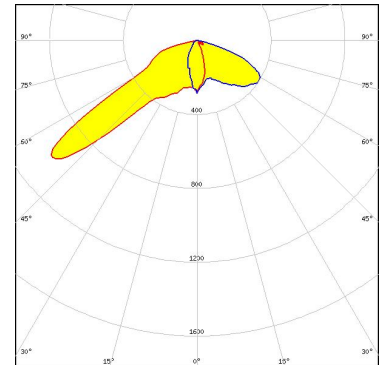

LED XP-G2 HE
 FWHM / FWTM Asymmetric
 Efficiency 95 %
 Peak intensity 0.9 cd/lm
 LEDs/each optic 1
 Light colour/type White
 Required components:

Light distribution files

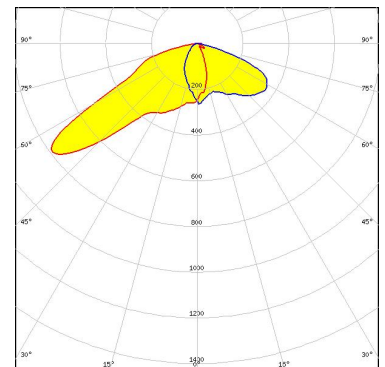

OPTICAL RESULTS (SIMULATED):



LED XP-G3
FWHM / FWTM Asymmetric
Efficiency 81 %
Peak intensity 0.8 cd/lm
LEDs/each optic 1
Light colour/type White
Required components:

Protective plate, glass

Light distribution files

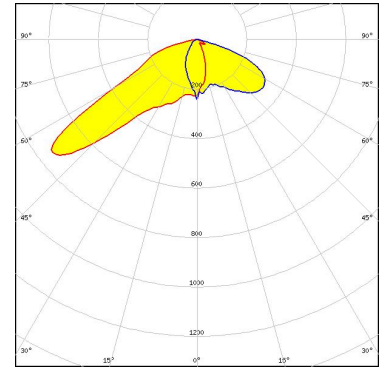

LED XP-G4
FWHM / FWTM Asymmetric
Efficiency 94 %
Peak intensity 1.2 cd/lm
LEDs/each optic 1
Light colour/type White
Required components:

Light distribution files

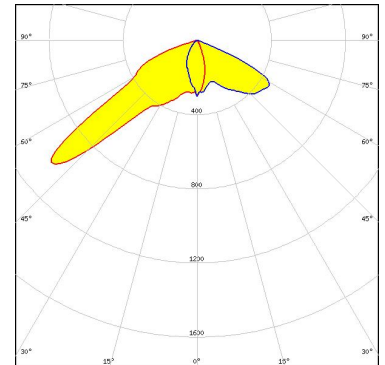

LED XP-P
FWHM / FWTM Asymmetric
Efficiency 84 %
Peak intensity 1.5 cd/lm
LEDs/each optic 1
Light colour/type White
Required components:

Protective plate, glass

Light distribution files

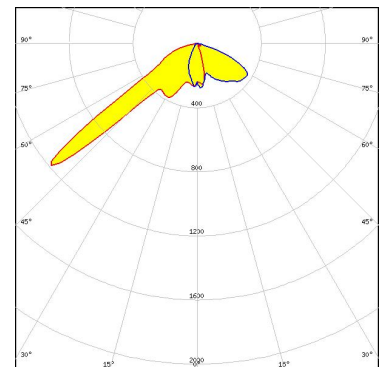

OPTICAL RESULTS (SIMULATED):



LED XT-E
 FWHM / FWTM Asymmetric
 Efficiency 93 %
 Peak intensity 1.1 cd/lm
 LEDs/each optic 1
 Light colour/type White
 Required components:

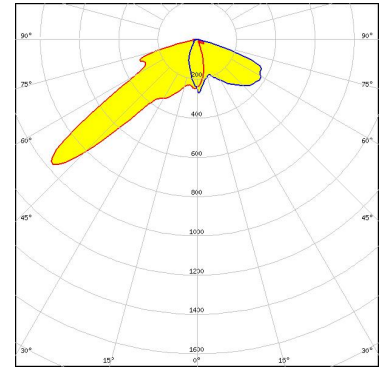

Light distribution files



LED XT-E
 FWHM / FWTM Asymmetric
 Efficiency 79 %
 Peak intensity 0.9 cd/lm
 LEDs/each optic 1
 Light colour/type White
 Required components:

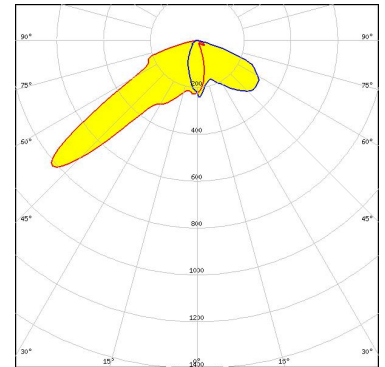

Protective plate, glass

Light distribution files



LED PrevaLED Brick HP 2x8
 FWHM / FWTM Asymmetric
 Efficiency 93 %
 Peak intensity 1.2 cd/lm
 LEDs/each optic 1
 Light colour/type White
 Required components:

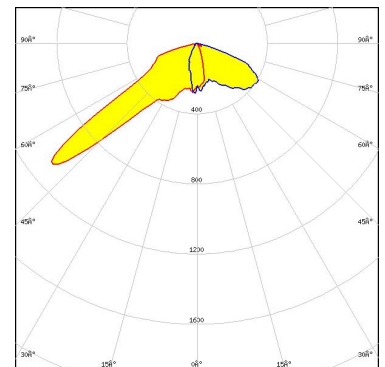

Light distribution files

OPTICAL RESULTS (SIMULATED):



LED LUXEON 5050 Round LES
 FWHM / FWTM Asymmetric
 Efficiency 85 %
 Peak intensity 0.8 cd/lm
 LEDs/each optic 1
 Light colour/type White
 Required components:

Protective plate, glass

Light distribution files

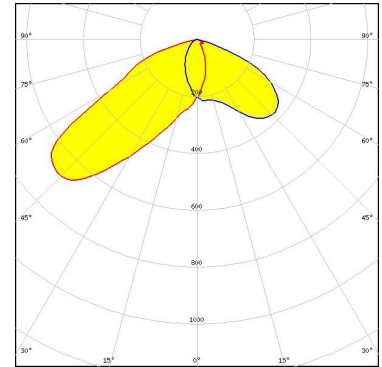

LED LUXEON 5050 Square LES
 FWHM / FWTM Asymmetric
 Efficiency 85 %
 Peak intensity 0.8 cd/lm
 LEDs/each optic 1
 Light colour/type White
 Required components:

Protective plate, glass

Light distribution files

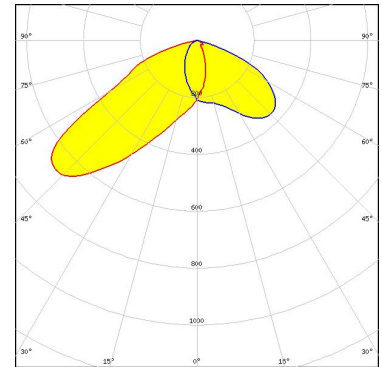

LED LUXEON 5050 Square LES
 FWHM / FWTM Asymmetric
 Efficiency 95 %
 Peak intensity 0.8 cd/lm
 LEDs/each optic 1
 Light colour/type White
 Required components:

Light distribution files

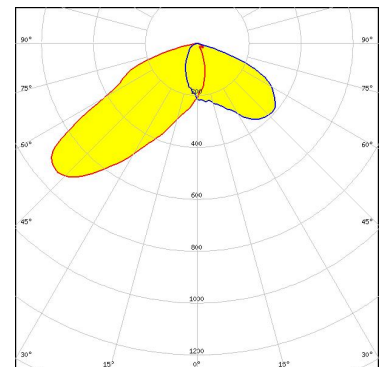

OPTICAL RESULTS (SIMULATED):



LED LUXEON HL2X
 FWHM / FWTM Asymmetric
 Efficiency 94 %
 Peak intensity 1 cd/lm
 LEDs/each optic 1
 Light colour/type White
 Required components:

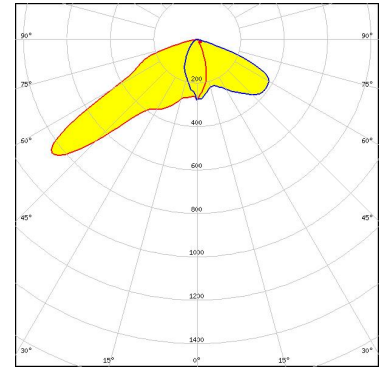

Light distribution files



LED LUXEON HL2X-P
 FWHM / FWTM Asymmetric
 Efficiency 94 %
 Peak intensity 0.9 cd/lm
 LEDs/each optic 1
 Light colour/type White
 Required components:

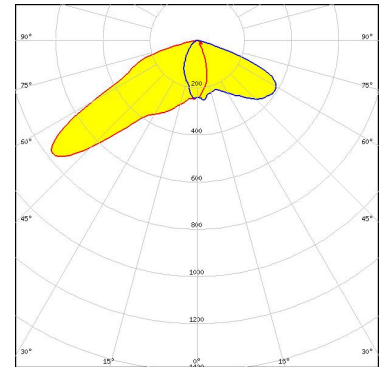

Light distribution files



LED LUXEON TX
 FWHM / FWTM Asymmetric
 Efficiency 95 %
 Peak intensity 1.1 cd/lm
 LEDs/each optic 1
 Light colour/type White
 Required components:

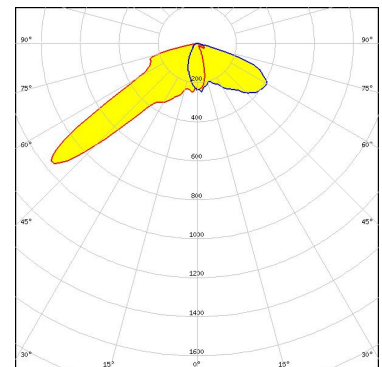

Light distribution files

OPTICAL RESULTS (SIMULATED):



LED LUXEON XR-HL2X (L2H2-xxxxxxxMLU010)
 FWHM / FWTM Asymmetric
 Efficiency 96 %
 Peak intensity 0.9 cd/lm
 LEDs/each optic 1
 Light colour/type White
 Required components:

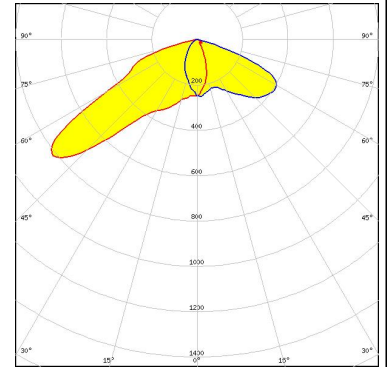

Light distribution files



LED LUXEON XR-HL2X (L2H2-xxxxxxxMLU010)
 FWHM / FWTM Asymmetric
 Efficiency 83 %
 Peak intensity 0.8 cd/lm
 LEDs/each optic 1
 Light colour/type White
 Required components:

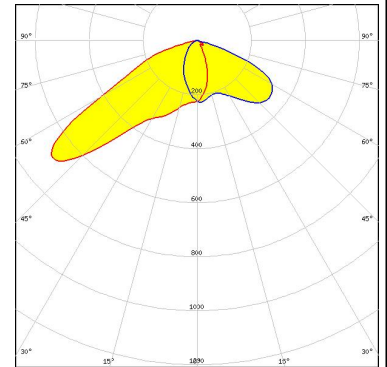

Protective plate, glass

Light distribution files



LED NV4WB35AM
 FWHM / FWTM Asymmetric
 Efficiency 96 %
 Peak intensity 0.9 cd/lm
 LEDs/each optic 1
 Light colour/type White
 Required components:

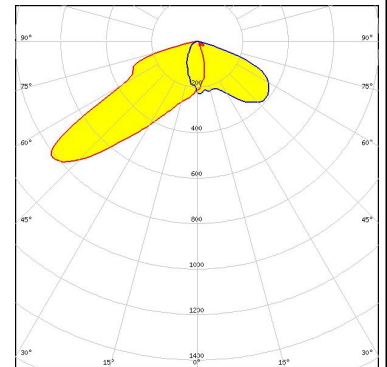

Light distribution files

OPTICAL RESULTS (SIMULATED):

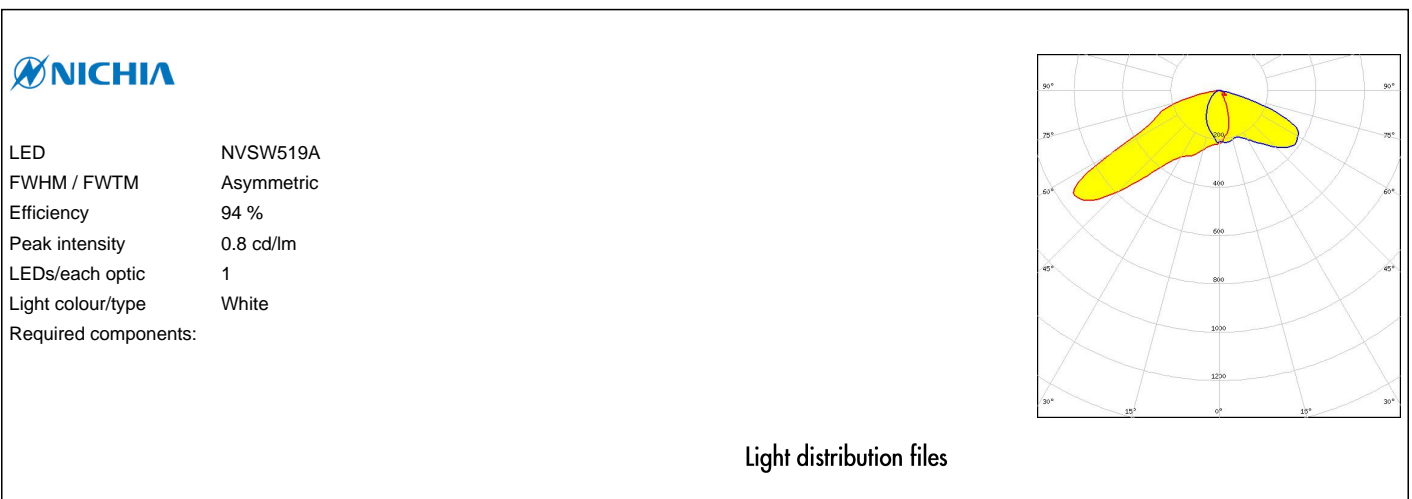
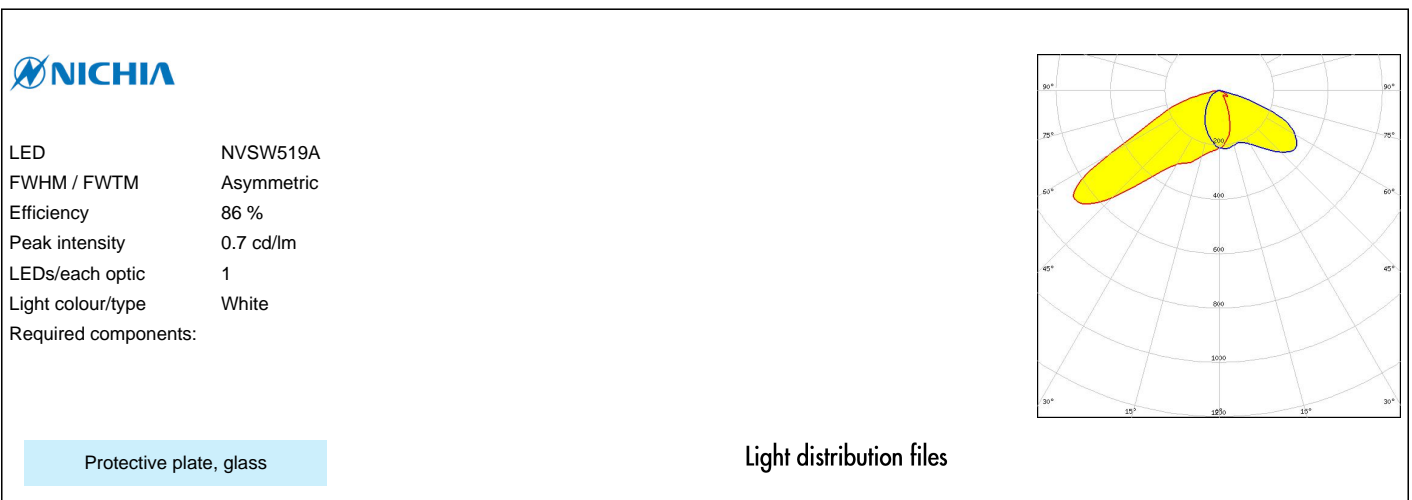
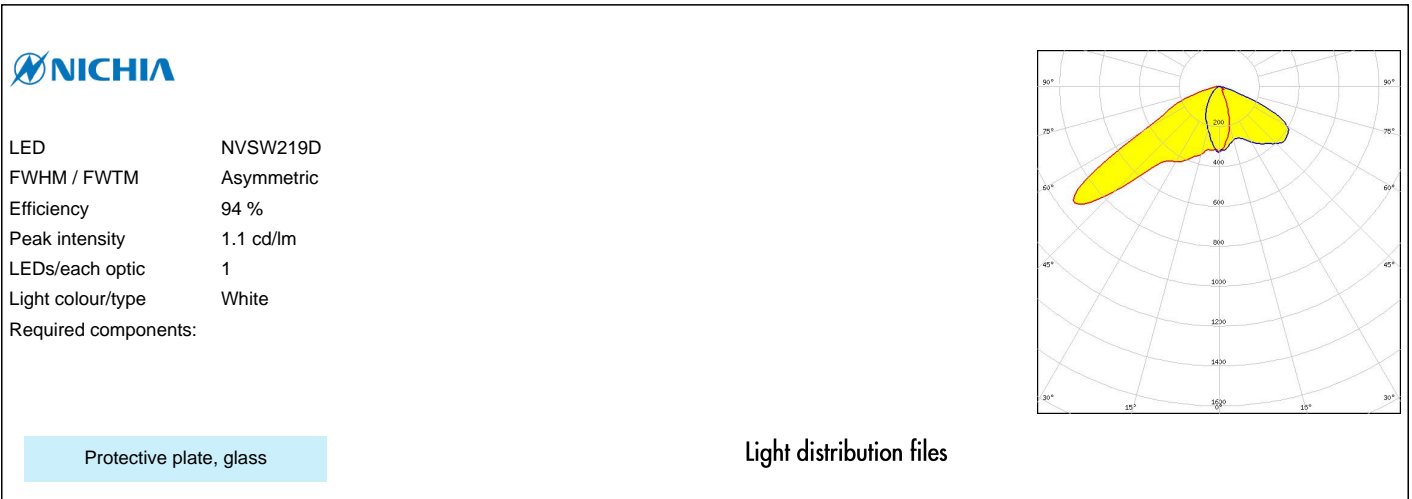

OPTICAL RESULTS (SIMULATED):



LED NVSxx19B/NVSxx19C
FWHM / FWTM Asymmetric
Efficiency 92 %
Peak intensity 1 cd/lm
LEDs/each optic 1
Light colour/type White
Required components:

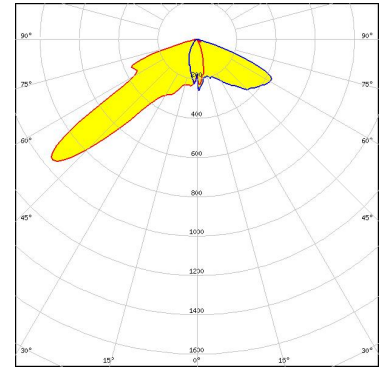

Light distribution files



LED Duris S8
FWHM / FWTM Asymmetric
Efficiency 94 %
Peak intensity 0.8 cd/lm
LEDs/each optic 1
Light colour/type White
Required components:

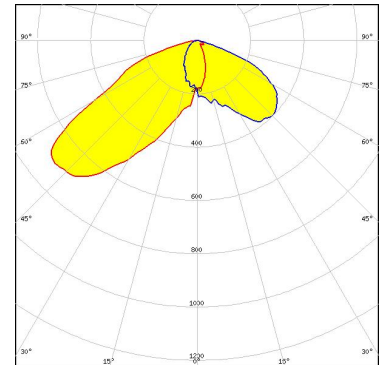

Light distribution files



LED OSCONIQ S 5050 (Q9LR32)
FWHM / FWTM Asymmetric
Efficiency 95 %
Peak intensity 0.8 cd/lm
LEDs/each optic 1
Light colour/type White
Required components:

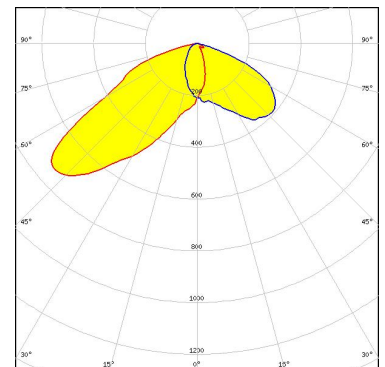

Light distribution files

OPTICAL RESULTS (SIMULATED):

OSRAM
Opto Semiconductors

LED OSCONIQ S 5050 (Q9LR35)
 FWHM / FWTM Asymmetric
 Efficiency 96 %
 Peak intensity 0.9 cd/lm
 LEDs/each optic 1
 Light colour/type White
 Required components:

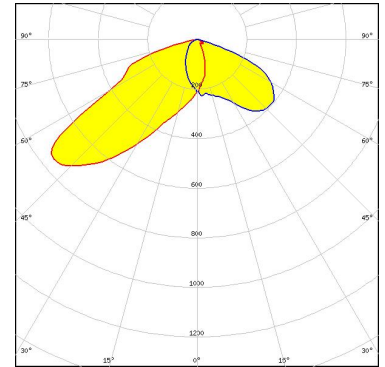

Light distribution files

OSRAM
Opto Semiconductors

LED OSLON Square CSSRM2/CSSRM3
 FWHM / FWTM Asymmetric
 Efficiency 80 %
 Peak intensity 0.9 cd/lm
 LEDs/each optic 1
 Light colour/type White
 Required components:

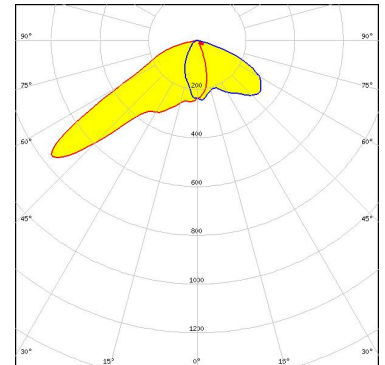

Protective plate, glass

Light distribution files

OSRAM
Opto Semiconductors

LED OSLON Square CSSRM2/CSSRM3
 FWHM / FWTM Asymmetric
 Efficiency 93 %
 Peak intensity 1.2 cd/lm
 LEDs/each optic 1
 Light colour/type White
 Required components:

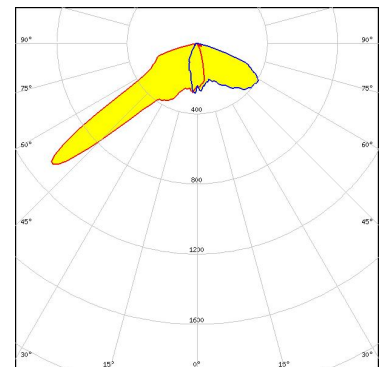

Light distribution files

OPTICAL RESULTS (SIMULATED):

SAMSUNG

LED LH351B
FWHM / FWTM Asymmetric
Efficiency 83 %
Peak intensity 0.7 cd/lm
LEDs/each optic 1
Light colour/type White
Required components:

Protective plate, glass

Light distribution files

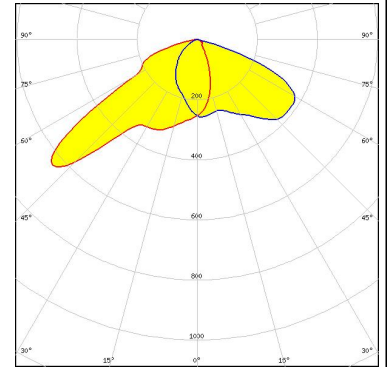

LED MJT 5050
FWHM / FWTM Asymmetric
Efficiency 95 %
Peak intensity 0.8 cd/lm
LEDs/each optic 1
Light colour/type White
Required components:

Light distribution files

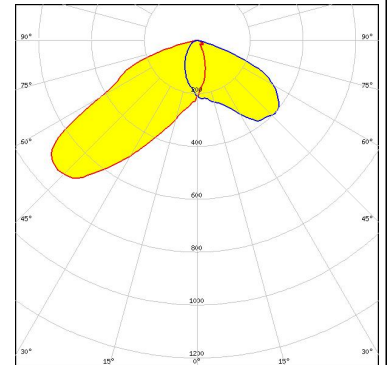

GENERAL INFORMATION:

NOTE: The typical beam angle will be changed by different color, chip size and chip position tolerance. The typical total beam angle is the full angle measured where the luminous intensity is half of the peak value.

MATERIALS:

As part of our continuous research and improvement processes, and to ensure the best possible quality and availability of our products, LEDiL reserves the right to change material grades without notice.

PRODUCT DATA USER AGREEMENT AND DISCLAIMER:

The measured data in the provided downloadable LEDiL Product Datasheets and Mechanical 2D-Drawings is rounded and provided as reference for planning. LEDiL Oy's optical specifications have been verified by conducting performance testing of the products in accordance with the company's quality system. The reported data are averaged results of multiple measurements with typical variation. LEDiL Oy reserves the right to without prior notification make changes and improvements to its products.

LEDiL Oy assumes neither warranty, nor guarantee nor any other liability of any kind for the contents and correctness of the provided data. The provided data has been generated with highest diligence but the provided data may in reality not represent the complete possible variation range of all intrinsic parameters. Therefore, in certain cases a deviation from the provided data could occur.

LEDiL Oy reserves the right to undertake technical changes of its products without further notification which could lead to changes in the provided data. LEDiL Oy assumes no liability of any kind for the possible deviation from any provided data or any other damage resulting from the usage of the provided data.

The user agrees to this disclaimer and user agreement with the download or usage of the provided files.

LEDiL Oy

Joensuunkatu 7
FI-24100 SALO
Finland

LEDiL Inc.

228 West Page Street
Suite D
Sycamore IL 60178
USA

Ledil Optics Technology (Shenzhen) Co., Ltd.

405 , Block B
Casic Motor Building
Shenzhen 518057
P.R.CHINA

Local sales and technical support

[www.ledil.com/
where_to_buy](http://www.ledil.com/where_to_buy)

Shipping locations

Poznan, Poland
Hong Kong, China

Distribution Partners

[www.ledil.com/
where_to_buy](http://www.ledil.com/where_to_buy)