

ECB4R3M12YM3L

1200 V, 4.3 mΩ, Silicon Carbide, Six-Pack Module

V_{DS}	1200 V
$R_{DS(on)}$	4.3 mΩ

Technical Features

- Fully SiC MOSFET-based for Ultra-Low Loss
- Comparative Tracking Index (CTI) > 600 V for Material Group I
- Extremely Low Power Loop Inductance (6.6 nH)
- High Performance Si₃N₄ Insulator
- Ultra-Reliable Interconnect Technologies
- AQG-324 Qualification

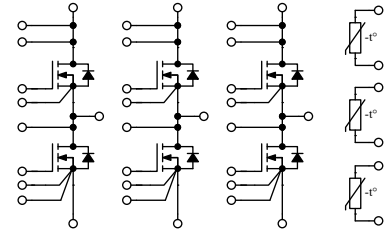
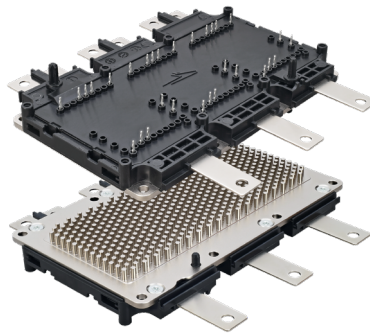

Typical Applications

- Automotive Traction Inverters
- Commercial, Construction, and Agricultural Vehicles
- Hybrid Electric Vehicles
- E-Mobility and Motor Drives
- Auxiliary Power Supplies
- Renewable Energy

System Benefits

- Direct-Cooled Pin Fin Baseplate
- Industry-Standard Footprint
- Press-fit Connection for Ease of Assembly
- Integrated NTC Temperature Sensors
- Long Phase Terminal to Accommodate Current Sensor

Maximum Parameters (Verified by Design)

Parameter	Symbol	Min.	Typ.	Max.	Unit	Conditions	Note
Drain-Source Voltage	V_{DS}			1200			
Gate-Source Voltage, Maximum Value	$V_{GS(max)}$	-10		+23	V	Transient	Note 1 Fig. 32
Gate-Source Voltage, Recommended	$V_{GS(op)}$		-4/+15			Static	
Implementable Current, Inverter Operation	I_{IMP}		411		A_{RMS}	$T_F = 65^\circ C, F_S = 10\text{ kHz}$	Fig. 22
DC Continuous Drain Current ($V_{GS} = 15\text{ V}, T_{VJ} \leq 175^\circ C$)	I_D		385		A	$T_F = 25^\circ C, \text{Flow Rate} = 10\text{ LPM}$	Notes 2, 3 Fig. 20
			330			$T_F = 65^\circ C, \text{Flow Rate} = 10\text{ LPM}$	
Pulsed Drain-Source Current	I_{DM}		1320			t_{Pmax} limited by T_{VJmax} $V_{GS} = 15\text{ V}, T_F = 65^\circ C$	
Power Dissipation	P_D		1103		W	$T_F = 25^\circ C, T_{VJ} \leq 175^\circ C$	Note 4 Fig. 21
Virtual Junction Temperature	$T_{VJ(op)}$	-40		175	$^\circ C$	Operation	

Note (1): Recommended turn-on gate voltage is 15 V with $\pm 5\%$ regulation tolerance

Note (2): Current limit calculated by $I_{D(max)} = \sqrt{(P_D / R_{DS(typ)}(T_{VJ(max)}, I_{D(max)}))}$

Note (3): Verified by design

Note (4): $P_D = (T_{VJ} - T_C) / R_{TH(JC,typ)}$



MOSFET Characteristics (Per Position) ($T_{vj} = 25\text{ }^{\circ}\text{C}$ Unless Otherwise Specified)

Parameter	Symbol	Min.	Typ.	Max.	Unit	Conditions	Note
Drain-Source Breakdown Voltage	$V_{(BR)DSS}$	1200				$V_{GS} = 0\text{ V}$, $T_{vj} = -40\text{ }^{\circ}\text{C}$	
Gate Threshold Voltage	$V_{GS(th)}$	1.8	2.5	3.6	V	$V_{DS} = V_{GS}$, $I_D = 84\text{ mA}$	
			2.0			$V_{DS} = V_{GS}$, $I_D = 84\text{ mA}$, $T_{vj} = 175\text{ }^{\circ}\text{C}$	
Zero Gate Voltage Drain Current	I_{DSS}		4	150	μA	$V_{GS} = 0\text{ V}$, $V_{DS} = 1200\text{ V}$	
Gate-Source Leakage Current	I_{GSS}		40	1000	nA	$V_{GS} = 15\text{ V}$, $V_{DS} = 0\text{ V}$	
Drain-Source On-State Resistance (Devices Only)	$R_{DS(on)}$		4.3	5.5	m Ω	$V_{GS} = 15\text{ V}$, $I_D = 350\text{ A}$	Fig. 2 Fig. 3
			7.5			$V_{GS} = 15\text{ V}$, $I_D = 350\text{ A}$, $T_{vj} = 175\text{ }^{\circ}\text{C}$	
Transconductance	g_{fs}		289		S	$V_{DS} = 20\text{ V}$, $I_{DS} = 350\text{ A}$	Fig. 4
			265			$V_{DS} = 20\text{ V}$, $I_{DS} = 350\text{ A}$, $T_{vj} = 175\text{ }^{\circ}\text{C}$	
Turn-On Switching Energy, $T_{vj} = 25\text{ }^{\circ}\text{C}$ $T_{vj} = 125\text{ }^{\circ}\text{C}$ $T_{vj} = 175\text{ }^{\circ}\text{C}$	E_{ON}		13.4		mJ	$V_{DS} = 600\text{ V}$, $I_D = 350\text{ A}$, $V_{GS} = -4\text{ V}/15\text{ V}$, $R_{G(OFF)} = 3.0\text{ }\Omega$, $R_{G(ON)} = 10.0\text{ }\Omega$, $L_B = 16.1\text{ nH}$	Fig. 11 Fig. 13
			12.5				
			12.4				
Turn-Off Switching Energy, $T_{vj} = 25\text{ }^{\circ}\text{C}$ $T_{vj} = 125\text{ }^{\circ}\text{C}$ $T_{vj} = 175\text{ }^{\circ}\text{C}$	E_{OFF}		7.6				
			7.5				
			7.6				
Internal Gate Resistance	$R_{G(int)}$		0.9		Ω	$f = 100\text{ kHz}$	
Input Capacitance	C_{iss}		25.6		nF	$V_{GS} = 0\text{ V}$, $V_{DS} = 800\text{ V}$, $V_{AC} = 25\text{ mV}$, $f = 100\text{ kHz}$	Fig. 9
Output Capacitance	C_{oss}		0.9				
Reverse Transfer Capacitance	C_{rss}		59.2				
Gate to Source Charge	Q_{GS}		288		nC	$V_{DS} = 800\text{ V}$, $V_{GS} = -4\text{ V}/15\text{ V}$ $I_D = 350\text{ A}$ Per IEC60747-8-4 pg 21	
Gate to Drain Charge	Q_{GD}		236				
Total Gate Charge	Q_G		848				
FET Thermal Resistance, Junction to Fluid	R_{thJF}		0.136		$^{\circ}\text{C}/\text{W}$	Flow Rate = 10 LPM, $T_F = 65\text{ }^{\circ}\text{C}$	Fig. 17

Diode Characteristics (Per Position) ($T_{vj} = 25\text{ }^{\circ}\text{C}$ Unless Otherwise Specified)

Parameter	Symbol	Min.	Typ.	Max.	Unit	Conditions	Note
Body Diode Forward Voltage	V_{SD}		6.0		V	$V_{GS} = -4\text{ V}$, $I_{SD} = 350\text{ A}$	Fig. 7
			5.2			$V_{GS} = -4\text{ V}$, $I_{SD} = 350\text{ A}$, $T_{vj} = 175\text{ }^{\circ}\text{C}$	
DC Source-Drain Current (Body Diode) ($V_{GS} = -4\text{ V}$, $T_{vj} \leq 175\text{ }^{\circ}\text{C}$)	I_{BD}		234		A	$T_F = 25\text{ }^{\circ}\text{C}$, Flow Rate = 10 LPM	
			180			$T_F = 65\text{ }^{\circ}\text{C}$, Flow Rate = 10 LPM	
Reverse Recovery Time	t_{RR}		50.4		ns	$V_{GS} = -4\text{ V}$, $I_{SD} = 350\text{ A}$, $V_R = 600\text{ V}$ $di/dt = 4.1\text{ A/ns}$, $T_{vj} = 175\text{ }^{\circ}\text{C}$	Fig. 31
Reverse Recovery Charge	Q_{RR}		3.2		μC		
Peak Reverse Recovery Current	I_{RRM}		104.4		A		
Reverse Recovery Energy, $T_{vj} = 25\text{ }^{\circ}\text{C}$ $T_{vj} = 125\text{ }^{\circ}\text{C}$ $T_{vj} = 175\text{ }^{\circ}\text{C}$	E_{RR}		0.1		mJ	$V_{DS} = 600\text{ V}$, $I_D = 350\text{ A}$, $V_{GS} = -4\text{ V}/15\text{ V}$, $R_{G(ON)} = 10.0\text{ }\Omega$, $L_B = 16.1\text{ nH}$	Fig. 14
			0.2				
			0.4				



Module Physical Characteristics

Parameter	Symbol	Min.	Typ.	Max.	Unit	Test Conditions
Package Resistance, (High-Side)			0.30		mΩ	T _F = 25°C, Note 5
Package Resistance, (Low-Side)			0.22			T _F = 25°C, Note 5
Comparative Tracking Index	CTI	600				
Baseplate Material			Cu+Ni			
Internal Isolator Material			Si ₃ Ni ₄			Basic insulation (class 1, IEC 61140)
Stray Inductance	L _{Stray}		6.6		nH	Between DC- and DC+
Case Temperature	T _C	-40		125	°C	
Mounting Torque	M _S	1.8		2.2	N-m	Baseplate, M4 bolts
		3.6		4.4		Power Terminals, M5 bolts
Weight	W		805		g	
Case Isolation Voltage	V _{isol}		4.2		kV	f = 0 Hz, t = 1 sec
Maximum Pressure in Cooling Circuit	p			2.5	bar	
Clearance Distance			4.3		mm	Terminal to Terminal
			4.5			Terminal to Heatsink
Creepage Distance			9.2			Terminal to Terminal
			9.8			Terminal to Heatsink

NTC Characteristics (T_{NTC} = 25 °C unless otherwise specified)

Parameter	Symbol	Min.	Typ.	Max.	Unit	Notes
Resistance at 25°C	R ₂₅	4750	5000	5250	Ω	
Tolerance of R ₁₀₀	ΔR/R	-9.22		9.89	%	T _{NTC} = 100 °C, R ₁₀₀ = 493.3 Ω
Beta Value for 25°C to 50°C	B _{25/50}	3307	3375	3443	K	
Beta Value for 25°C to 80°C	B _{25/80}	3346	3414	3482	K	
Beta Value for 25°C to 100°C	B _{25/100}	3368	3436	3503	K	
Maximum Power Dissipation	P ₂₅		1.4		mW	

Note (5): Total Effective Resistance (Per Switch Position) = MOSFET R_{DS(on)} + Switch Position Package Resistance



Typical Performance

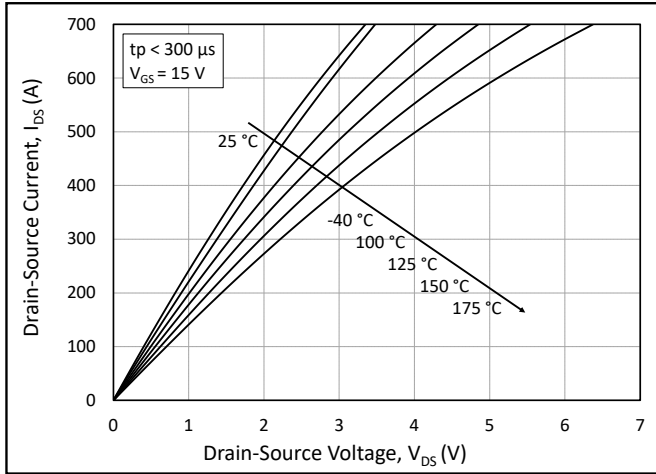

Figure 1. Output Characteristics for Various Junction Temperatures

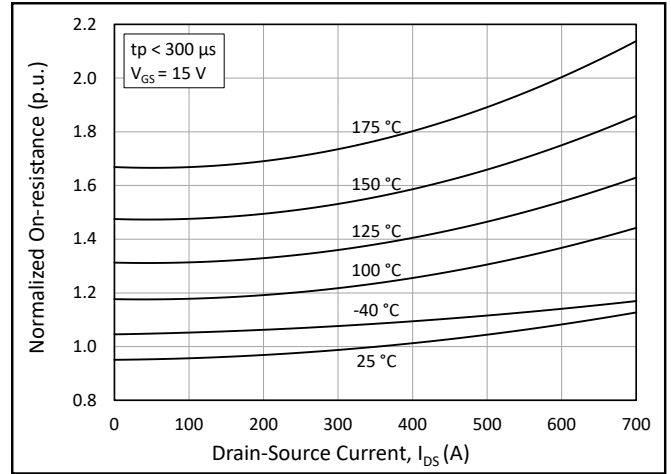

Figure 2. Normalized On-State Resistance vs. Drain Current for Various Junction Temperatures

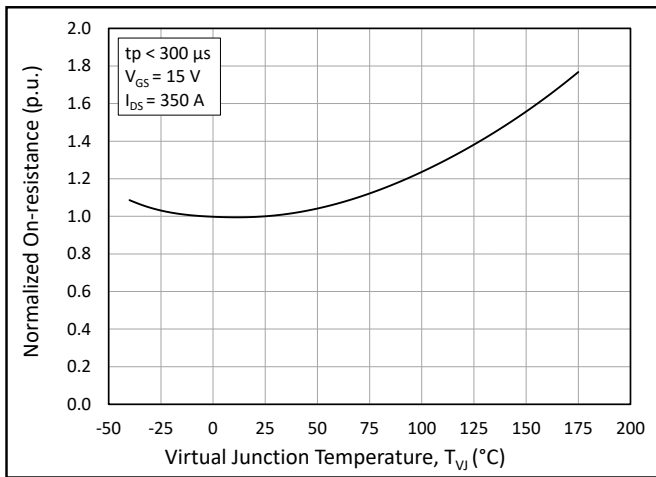

Figure 3. Normalized On-State Resistance vs. Junction Temperature

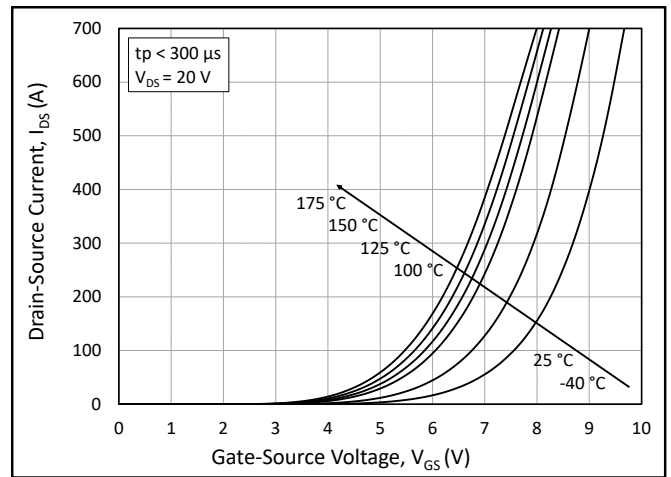

Figure 4. Transfer Characteristic for Various Junction Temperatures

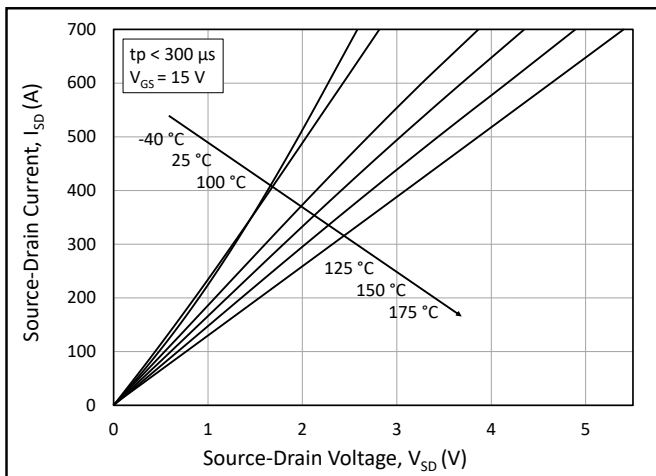

Figure 5. 3rd Quadrant Characteristic vs. Junction Temperatures at $V_{GS} = 15\text{ V}$

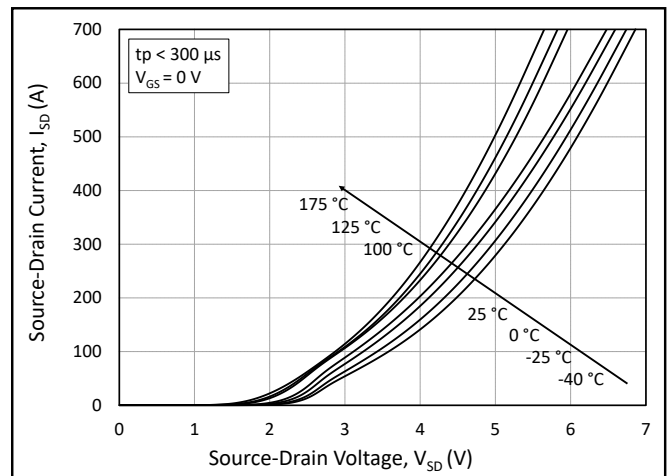

Figure 6. 3rd Quadrant Characteristic vs. Junction Temperatures at $V_{GS} = 0\text{ V}$ (Body Diode)



Typical Performance

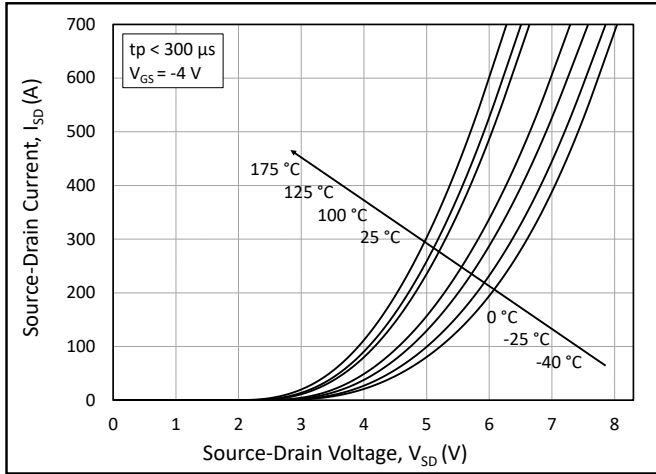

Figure 7. 3rd Quadrant Characteristic vs. Junction Temperatures at $V_{GS} = -4$ V (Body Diode)

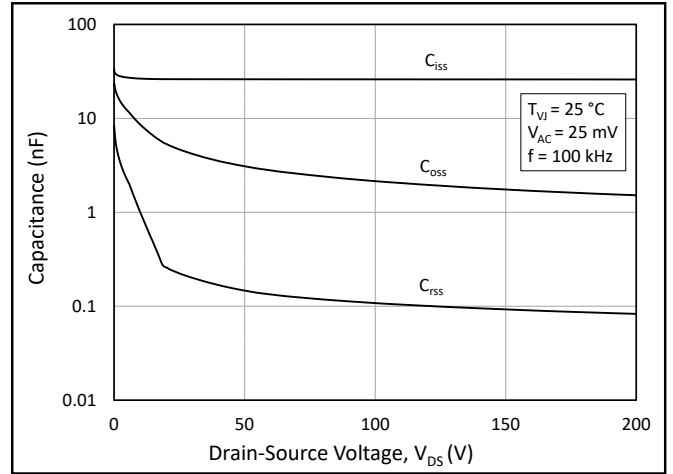

Figure 8. Typical Capacitances vs. Drain to Source Voltage (0 - 200 V)

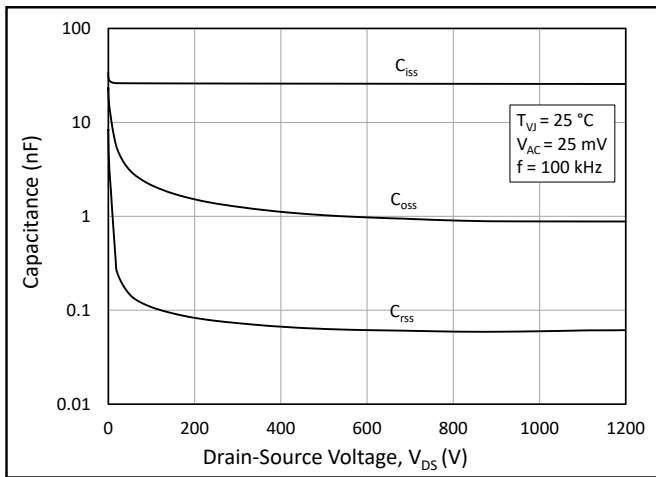

Figure 9. Typical Capacitances vs. Drain to Source Voltage (0 - 1200V)

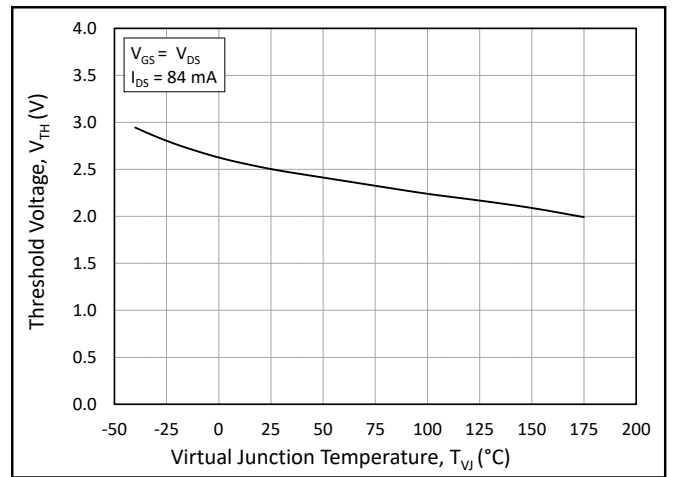

Figure 10. Threshold Voltage vs. Junction Temperature

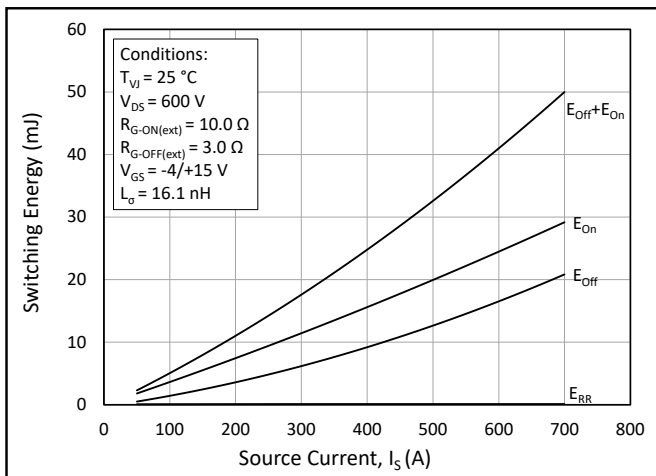

Figure 11. Switching Energy vs. Drain Current ($V_{DS} = 600$ V)

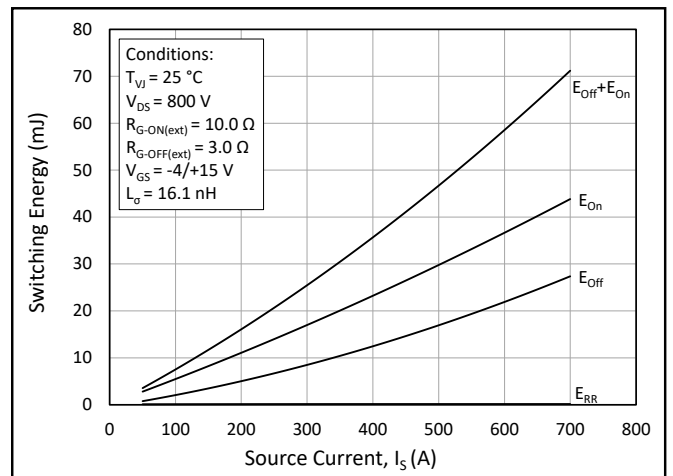

Figure 12. Switching Energy vs. Drain Current ($V_{DS} = 800$ V)

Typical Performance

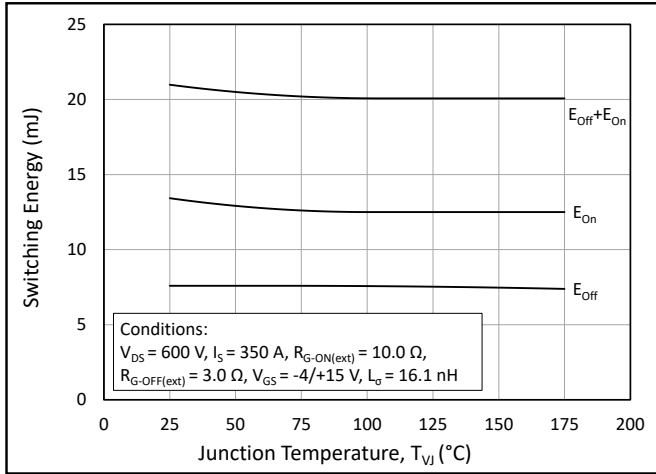

Figure 13. MOSFET Switching Energy vs. Junction Temperature

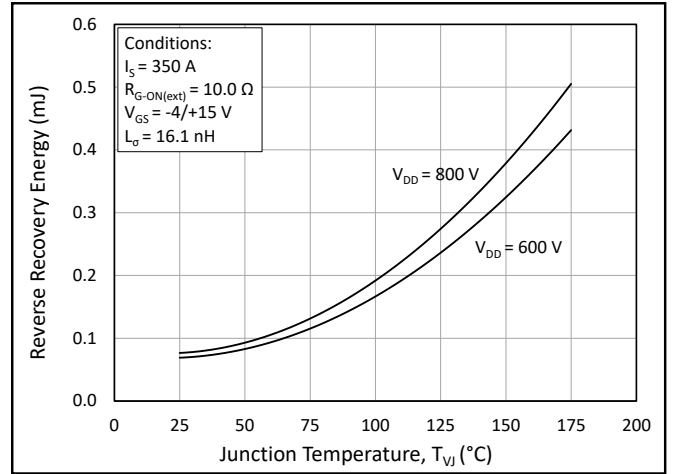

Figure 14. Reverse Recovery Energy vs. Junction Temperature

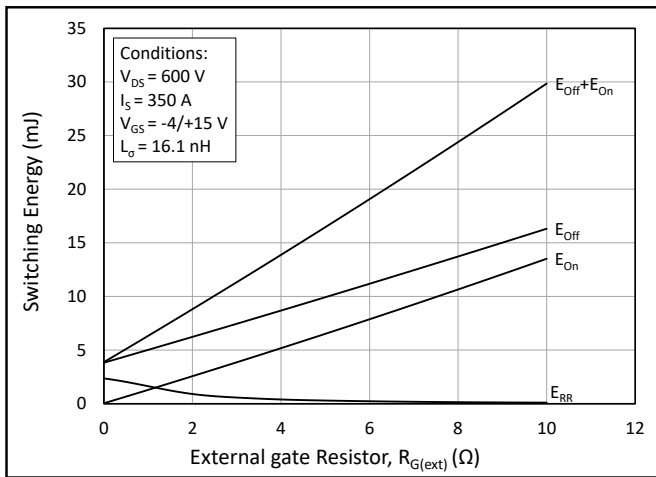

Figure 15. MOSFET Switching Energy vs. External Gate Resistance

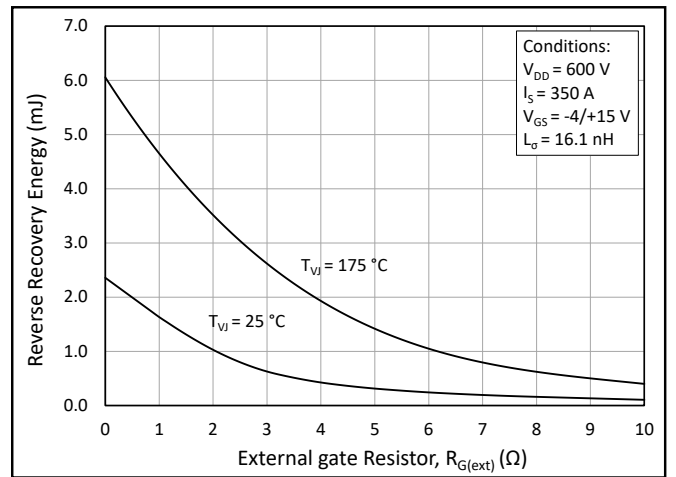

Figure 16. Reverse Recovery Energy vs. External Gate Resistance

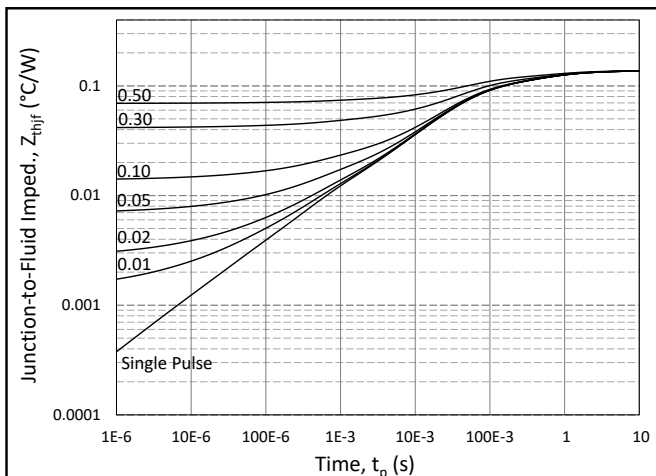

Figure 17. MOSFET Junction to Fluid Transient Thermal Impedance, $Z_{th,JF}$ (°C/W)

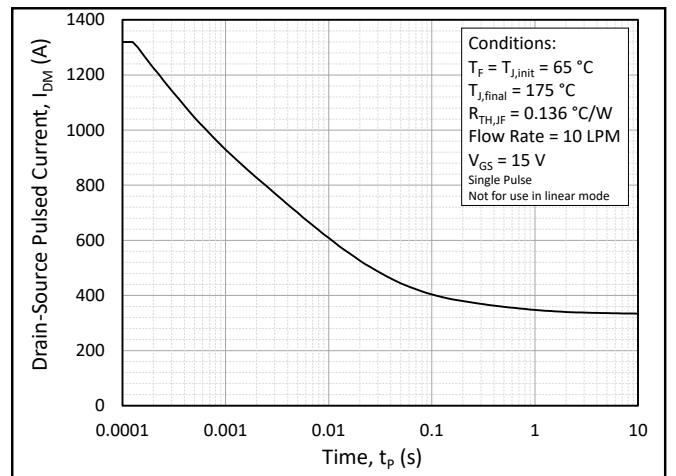

Figure 18. Pulsed Current SOA



Typical Performance

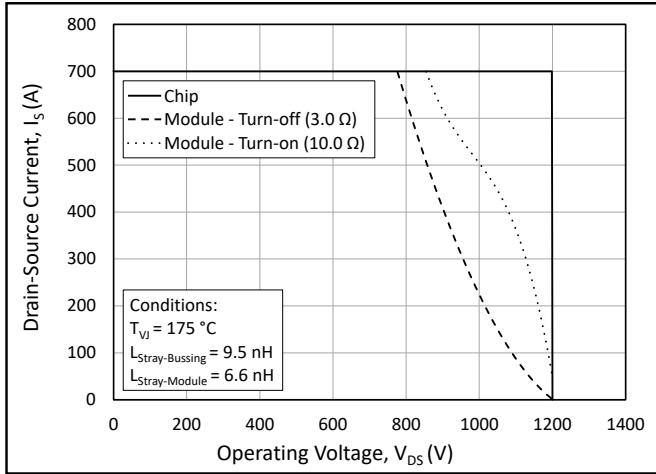

Figure 19. Switching Safe Operating Area

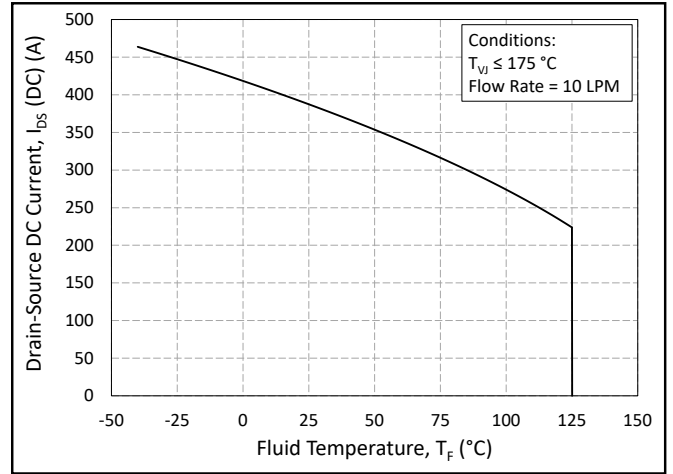

Figure 20. Continuous Drain Current Derating vs. Fluid Temperature

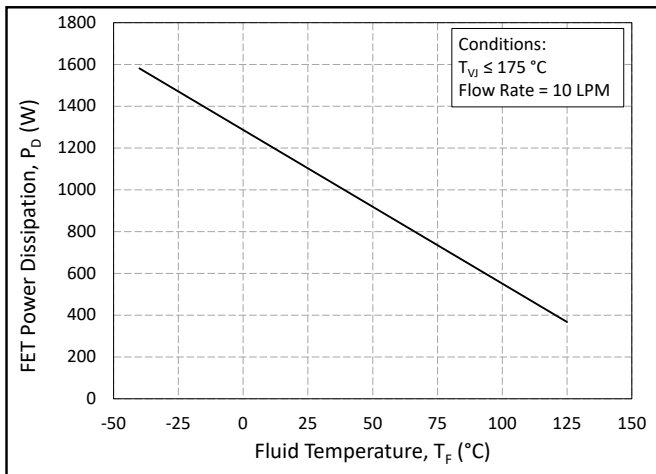

Figure 21. Maximum Power Dissipation Derating vs. Fluid Temperature

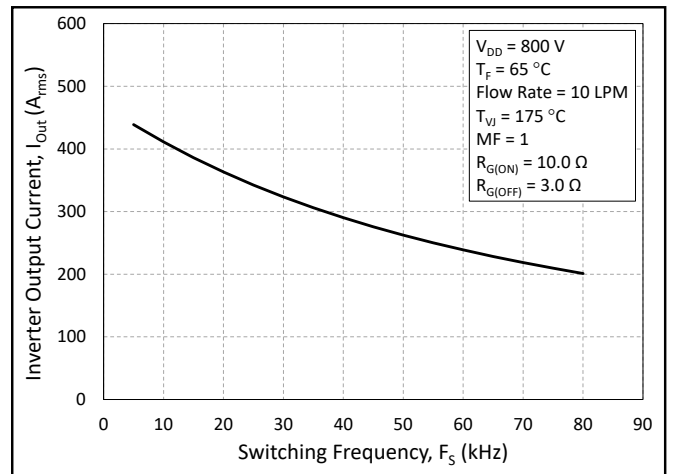

Figure 22. Typical Output Current Capability vs. Switching Frequency (Inverter Application)

Timing Characteristics

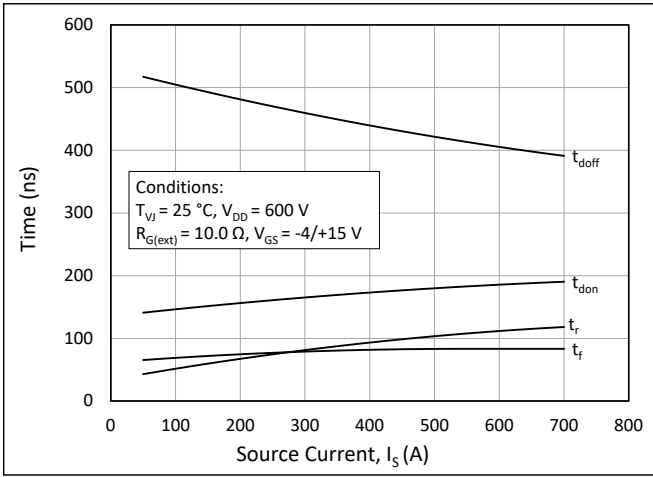

Figure 23. Timing vs. Source Current

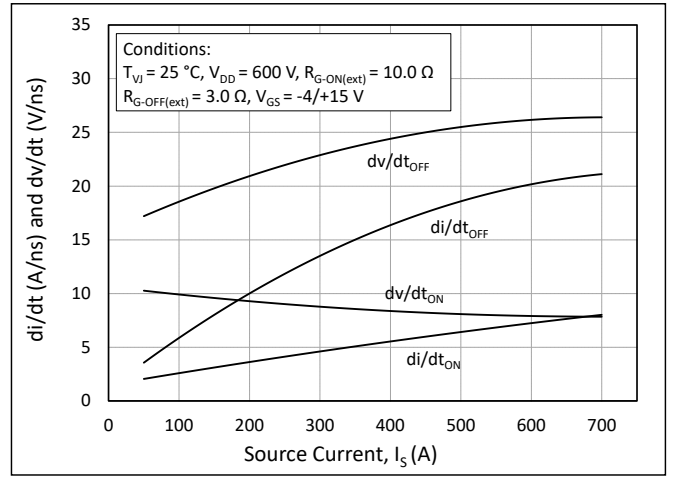

Figure 24. dv/dt and di/dt vs. Source Current

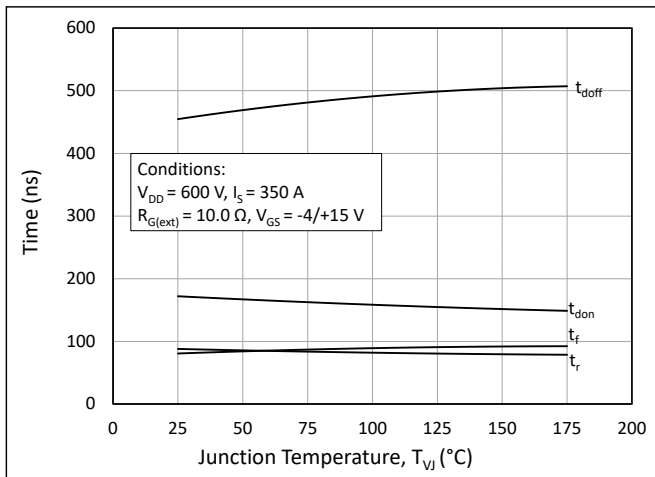

Figure 25. Timing vs. Junction Temperature

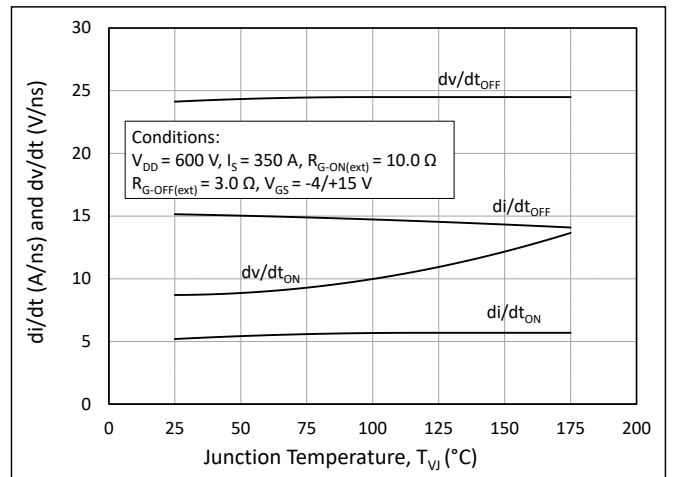

Figure 26. dv/dt and di/dt vs. Junction Temperature

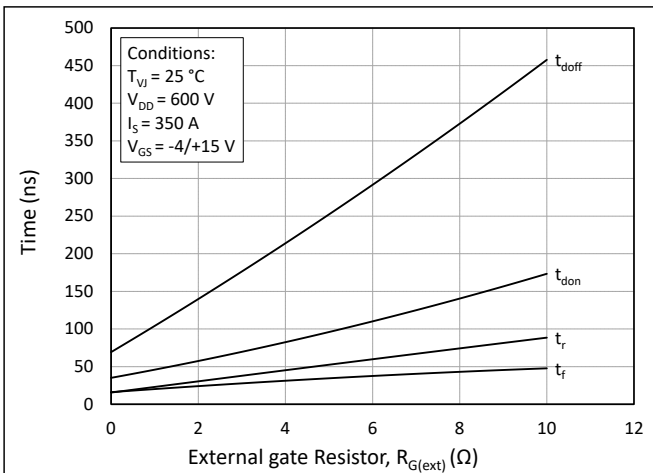

Figure 27. Timing vs. External Gate Resistance

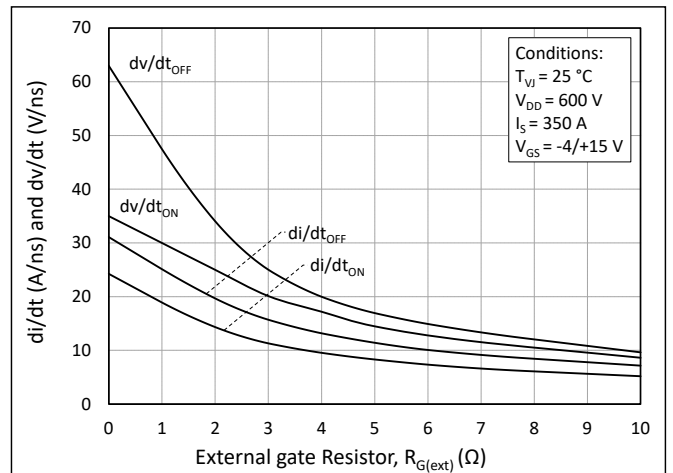

Figure 28. dv/dt and di/dt vs. External Gate Resistance

Definitions

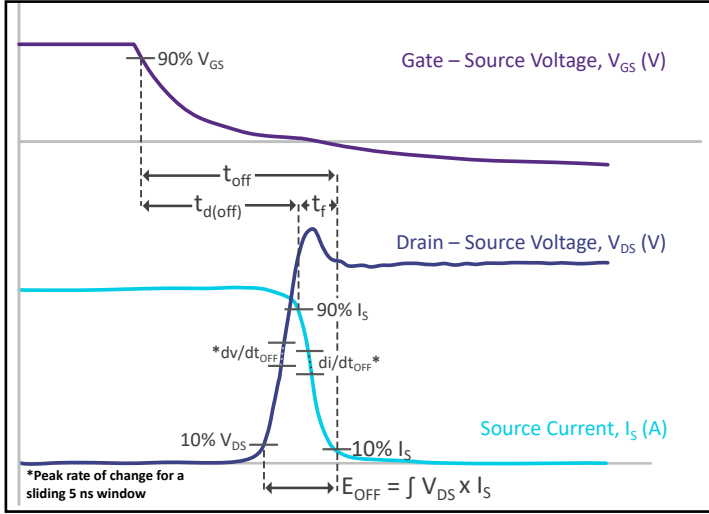

Figure 29. Turn-off Transient Definitions

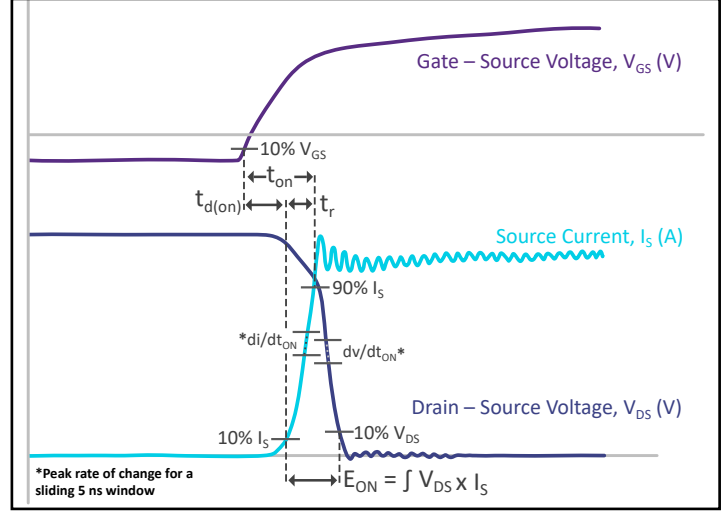

Figure 30. Turn-on Transient Definitions

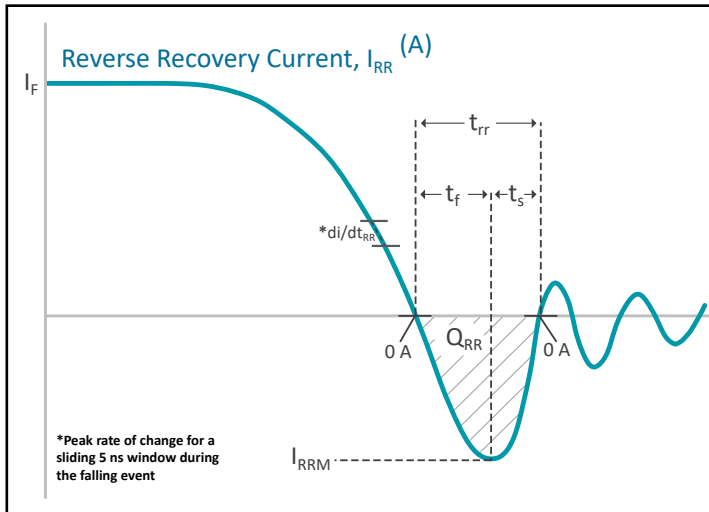

Figure 31. Reverse Recovery Definitions

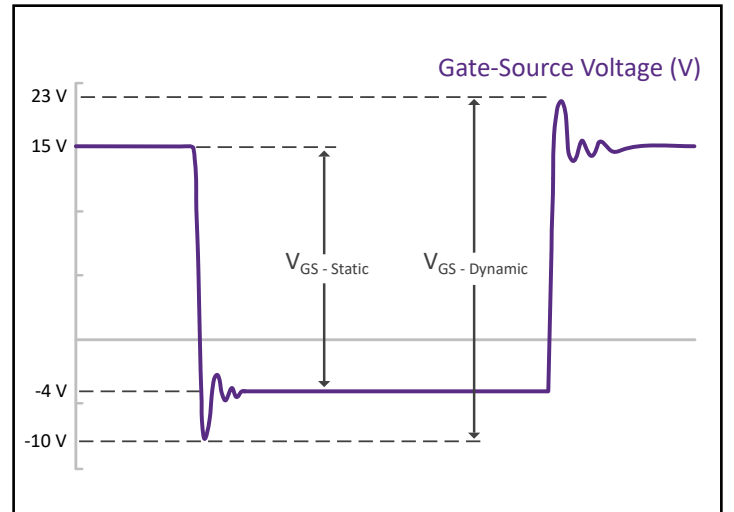
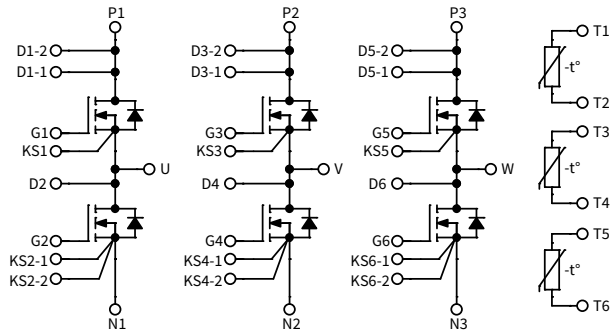

Figure 32. V_{GS} Transient Definitions

Note (6): A gate driver featuring the IXDD614SI gate driver IC was used to evaluate dynamic performance. The typical driver high-state output resistance of 0.4 Ω and low-state output resistance of 0.3 Ω are not included in the $R_{G(ext)}$ values on this datasheet.



Schematic and Pin Out



Package Dimension

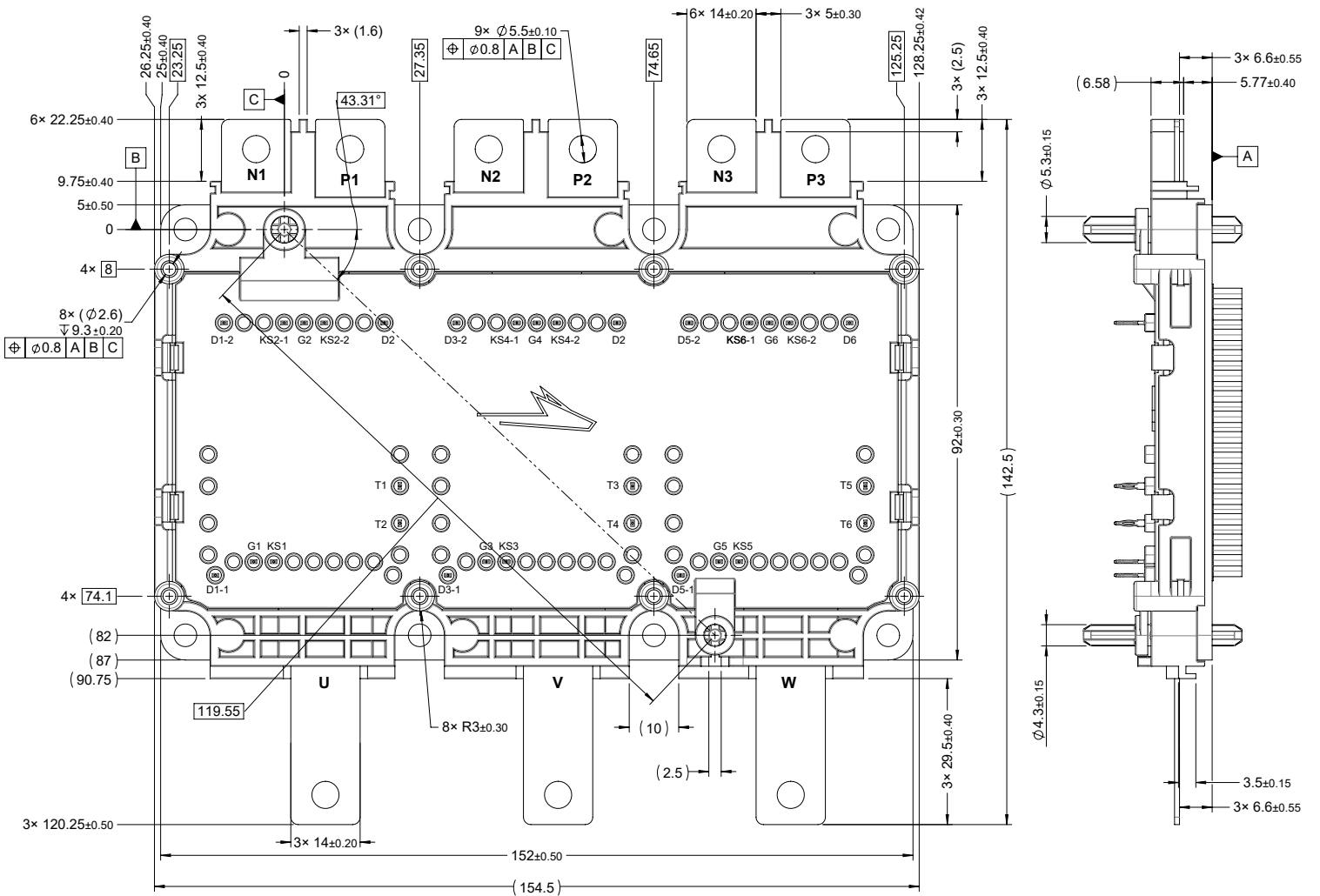

Package Dimension (mm)

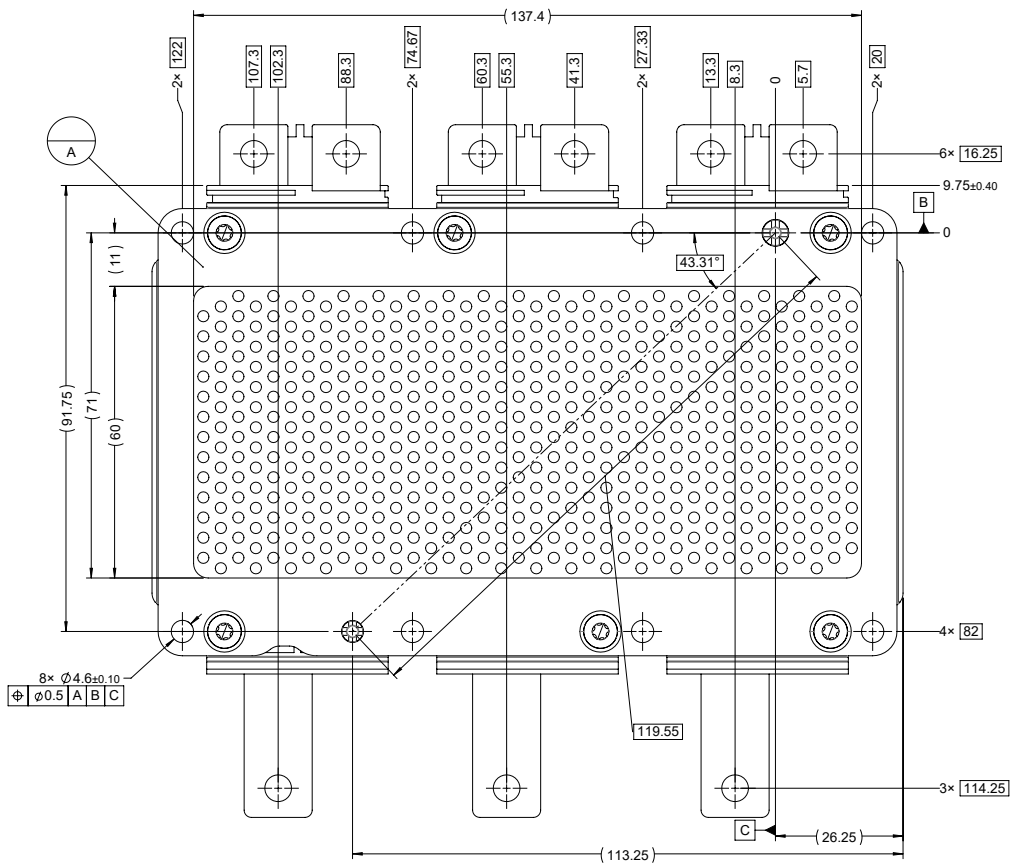
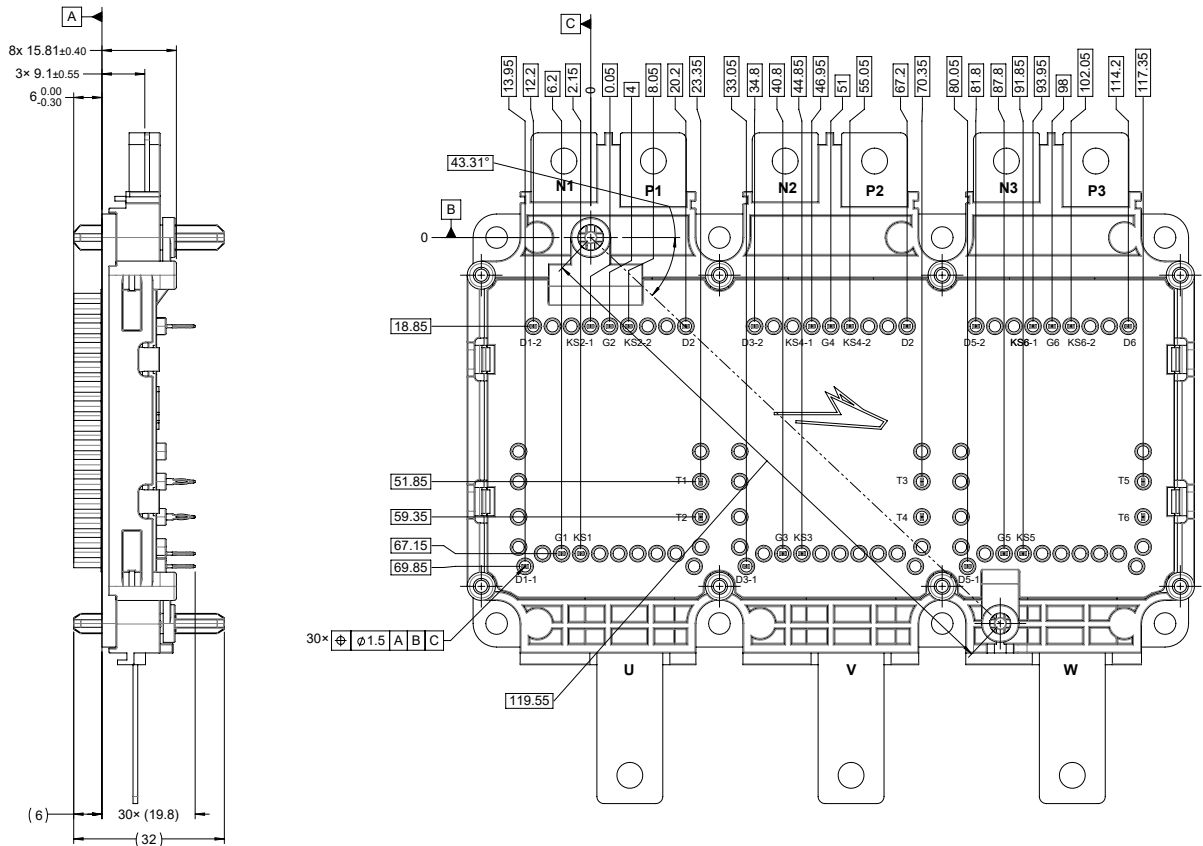



Supporting Links & Tools

Evaluation Tools & Support

- [SpeedFit 2.0 Design Simulator™](#)
- [Technical Support Forum](#)
- [LTspice and PLECS Models](#)
- [KIT-CRD-CIL12N-YMC: Dynamic Performance Evaluation Board for the YM3 Six-pack Module](#)

Dual-Channel Gate Driver Board

- [CGD12HB00D: Differential Transceiver Daughter Board Companion Tool for Differential Gate Drivers](#)
- [CGD1700HB2M-UNA: Wolfspeed Gate Driver Board](#)
- [EVAL-ADUM4146WHB1Z: Analog Devices® Gate Driver Board](#)
- [UCC21710QDWEVM-054: Texas Instruments® Gate Driver Board](#)
- [NXP EV Traction Inverter Control Reference Design Gen 3](#)

Application Notes

- [PRD-04814: Design Options for Wolfspeed® Silicon Carbide MOSFET Gate Bias Power Supplies](#)
- [PRD-06379: Environmental Considerations for Power Electronics Systems](#)
- [PRD-08333: Wolfspeed Module CIL Evaluation Kits User Guide](#)
- [PRD-08376: Thermal Characterization Methods and Applications](#)
- [PRD-07845: Power Module Baseplate Capacitance and Electromagnetic Compatibility](#)
- [PRD-08710: Measuring Stray Inductance in Power Electronics Systems](#)
- [PRD-08911: Considerations for Current Balancing in Paralleled SiC Power Modules](#)
- [PRD-09035: Power Module RC Thermal Models User Guide](#)



Notes & Disclaimers

WOLFSPEED PROVIDES TECHNICAL AND RELIABILITY DATA, DESIGN RESOURCES, APPLICATION OR OTHER DESIGN ADVICE, WEB TOOLS, AND OTHER RESOURCES “AS IS” AND WITH ALL FAULTS, AND DISCLAIMS ALL WARRANTIES, EXPRESS AND IMPLIED, WITH RESPECT THERETO, INCLUDING WITHOUT LIMITATION ANY IMPLIED WARRANTIES OF MERCHANTABILITY, SUITABILITY, FITNESS FOR A PARTICULAR PURPOSE, OR NON-INFRINGEMENT OF THIRD-PARTY INTELLECTUAL PROPERTY RIGHTS.

This document and the information contained herein are subject to change without notice. Any such change shall be evidenced by the publication of an updated version of this document by Wolfspeed. No communication from any employee or agent of Wolfspeed or any third party shall effect an amendment or modification of this document. No responsibility is assumed by Wolfspeed for any infringement of patents or other rights of third parties which may result from use of the information contained herein. No license is granted by implication or otherwise under any patent or patent rights of Wolfspeed.

The information contained in this document (excluding examples, as well as figures or values that are labeled as “typical”) constitutes Wolfspeed’s sole published specifications for the subject product. “Typical” parameters are the average values expected by Wolfspeed in large quantities and are provided for informational purposes only. Any examples provided herein have not been produced under conditions intended to replicate any specific end use. Product performance can and does vary due to a number of factors.

This product has not been designed or tested for use in, and is not intended for use in, any application in which failure of the product would reasonably be expected to cause death, personal injury, or property damage. For purposes of (but without limiting) the foregoing, this product is not designed, intended, or authorized for use as a critical component in equipment implanted into the human body, life-support machines, cardiac defibrillators, and similar emergency medical equipment; air traffic control systems; or equipment used in the planning, construction, maintenance, or operation of nuclear facilities. Notwithstanding any application-specific information, guidance, assistance, or support that Wolfspeed may provide, the buyer of this product is solely responsible for determining the suitability of this product for the buyer’s purposes, including without limitation (1) selecting the appropriate Wolfspeed products for the buyer’s application, (2) designing, validating, and testing the buyer’s application, and (3) ensuring the buyer’s application meets applicable standards and any other legal, regulatory, and safety-related requirements.

RoHS Compliance

The levels of RoHS restricted materials in this product are below the maximum concentration values (also referred to as the threshold limits) permitted for such substances, or are used in an exempted application, in accordance with EU Directive 2011/65/EC (RoHS2), as implemented January 2, 2013. RoHS Declarations for this product can be obtained from your Wolfspeed representative or from the Product Documentation sections of www.wolfspeed.com.

REACH Compliance

REACH substances of high concern (SVHCs) information is available for this product. Since the European Chemical Agency (ECHA) has published notice of their intent to frequently revise the SVHC listing for the foreseeable future, please contact your Wolfspeed representative to ensure you get the most up-to-date REACH SVHC Declaration. REACH banned substance information (REACH Article 67) is also available upon request.

Contact info:

4600 Silicon Drive
Durham, NC 27703 USA
Tel: +1.919.313.5300
www.wolfspeed.com/power